

UPDATED
EDITION

New Roof Construction MANUAL

2020 Edition



Cover House Photos:

Top: Courtesy: Robert A. Cardello Architects. Photo Courtesy: Dennis Carbo Photography

Bottom left: Courtesy of BCI

Bottom right: Photo Courtesy: Tony Bonura

INTRODUCTION

New Roof Construction Manual

This manual is intended for use with Western Red Cedar and Alaskan Yellow Cedar shake and shingle application only. Western Red Cedar and Yellow Cedar products manufactured by Cedar Shake & Shingle Bureau® (“CSSB”) members are labeled with the “Certi” brand name. The species is indicated by either “Yellow” or “Red” Cedar at the top of the label. For ease of reference this manual refers to “Certi-label® Western Cedar” and the term is understood to include both Western Red Cedar and Alaskan Yellow Cedar products manufactured by CSSB members.

Material for this manual has been compiled from various authoritative sources, and many of the construction methods shown herein have been developed by the shake and shingle specialists in both the United States and Canada. The design and application details and methods of construction reflect current good building practice. Other options are possible but ensure that you check with your local building code official for approval.

Certi-label® Products

Cedar shakes and shingles manufactured by Cedar Shake & Shingle Bureau® (“CSSB”) members are the only products labeled with the “Certi” brand name. Certi-label® cedar shakes and shingles are made by experienced craftsmen who take pride in their trade and the quality of their product. Despite their varying sizes and sometimes remote locations, member mills are bound together by a rigid quality code. Unannounced independent inspections conducted by accredited third party agencies ensure that product quality is maintained. Products are inspected to conform with various local, national and international codes and standards (contact the CSSB for specific details).

Each bundle of product has the mill’s distinctive Certi-label® tucked under the bundle strap. Asking for “the Blue Label®” or “number one blue label” is not specific enough: CSSB members’ products are the only ones with the *Certi* brand name on the label.

Note:

- ONLY experienced professionals who follow proper safety and workmanship practices should implement the information contained herein.
- Different climates have different code requirements. Ensure the right products and installation methods are used per the building code official in your area.
- Confirm labels required for warranty registration BEFORE purchasing product. Ensure warranty registration details are listed on purchase order.
- Refer to www.cedarbureau.org for project inspiration and photo portfolio.

Note: This manual replaces all previous versions of the “Cedar Shake and Shingle Bureau New Roof Construction Manual”.

CONTENTS

Certi-label® Products	pages 1-2
General Design & Application Details	pages 3-5
Mansard Roof Details	page 6
Low Slope Roof Details	page 7
Hip & Ridge Details	page 8
Roof Juncture Details	pages 9-10
Roof Valley Flashing Details	page 11
Roof Projection Flashing Details	page 12
Roof Fastener Guidelines	pages 13-14
Ventilation Details	pages 15-16
Specialty Roof Deck Details	pages 17-18
Cold Roof System Details	pages 18-19
High Humidity Area Details	pages 20-21
Care & Maintenance Overview	pages 22-23
Coverage & Exposure Tables	page 24
Specification Guidelines	pages 25-26
How to Read a Certi-label®	page 27
CSSB History	pages 28

This manual presents best practices developed over more than a century of Cedar Shake and Shingle Bureau® (“CSSB”) history. Please contact CSSB technical staff with Certi-label® product or installation questions. The contents of this manual are not intended to supersede local jurisdiction requirements or building code. ALWAYS check with your local code jurisdiction for approval of any installation modifications, including accessory building materials.

CERTI-LABEL® CEDAR SHAKES

Certi-Split® Handsplit



These shakes have split faces and sawn backs. Cedar logs are first cut into desired lengths. Blanks or boards of proper thickness are split and then run diagonally through a bandsaw to produce two tapered shakes from each blank. Available in Premium Grade (100% edge grain) or Number 1 Grade (Up to 20% flat grain allowed in each bundle).

Certi-Sawn® Tapersawn



These shakes are sawn both sides. Premium and Number 1 Grades are the most common. Premium Grade is 100% edge grain, 100% clear and 100% heartwood. Number 1 Grade allows up to 20% flat grain in each bundle. Number 2 and 3 Grades are also available.

Certi-Split® Tapersplit



Produced by hand, using a sharp bladed steel froe and a mallet. The natural shingle-like taper is achieved by reversing the block, end-for-end, with each split. Premium Grade only. (100% edge grain).

Certi-Split® Straight-Split



Produced by machine or in the same manner as tapersplit shakes except that by splitting from the same end of the block, the shakes acquire the same thickness throughout. Premium Grade only. (100% edge grain).

CERTIGRADE® CEDAR SHINGLES

Number 1 Blue Label®



The premium grade of shingles for roofs and sidewalls. These top-grade shingles are 100% heartwood, 100% clear and 100% edge grain. Available in 16" or 18" or 24" lengths.

Number 2 Red Label



A good grade for many applications. Not less than 10" clear on 16" shingles, 11" clear on 18" shingles and 16" clear on 24" shingles. Flat grain and limited sapwood are permitted in this grade.

Number 3 Black Label



A utility grade for economy applications and secondary buildings. Not less than 6" clear on 16" and 18" shingles, 10" clear on 24" shingles.

Number 4 Undercoursing



A utility grade for undercoursing of double coursed sidewalls only. Not a roofing material and not to be used as a starter course for roofs.



Pressure-Impregnated Treated Products

Certi-label® products can also be treated. Products are available either fire-retardant-treated OR preservative-treated. Special care must be taken to follow the treatment company’s recommended installation instructions.



Certi-Guard® Fire-Retardant Treated Cedar Shakes and Shingles

Premium and Number 1 Grades of Certi-Split® shakes, Certi-Sawn® shakes, and Number 1 Grades of Certigrade® shingles are available pressure-impregnated with fire retardants. Certi-Guard® products may be used for Class A, B and C roof systems. Contact the treatment company for treatment warranty information, accessory product requirements (including recommended fastener types) and application details for treated cedar material. Local code jurisdictions have additional information regarding applications in specific areas.



Certi-Last® Preservative-Treated Cedar Shakes and Shingles

Premium and Number 1 Grades of Certi-Split® shakes, Certi-Sawn® shakes, and Number 1 Grades of Certigrade® shingles are available preservative-treated by pressure-impregnation process. This product is ideal in areas of high humidity. Specify the Certi-Last® treating label for this extra protection. Contact the treatment company for treatment warranty information, accessory product requirements (including recommended fastener types) and application details for treated cedar material.



Note:

- Once Western Cedar shakes and shingles are pressure-impregnated treated you must contact the treatment company to determine if a finish, such as paint or stain or cleaning solution/agent, is allowable.
- Confirm product labels required for warranty registration BEFORE purchasing product. Ensure warranty registration details are listed on purchase order.

TIPS

Note:

- Once Western Cedar shingles and shakes are pressure-impregnated treated you must contact the treatment company to determine if a finish, such as paint or stain or cleaning solution/agent, is allowable.
- Confirm product labels required for warranty registration BEFORE purchasing product. Ensure warranty registration details are listed on purchase order.
- Be sure that felt interlay paper on shakes does not extend below a line that is twice the exposure above the butt (i.e. a 24" shake at 10", exposure would have felt applied 20" above the butt).
- Never interlay shingles with felt.
- Keyways must not be aligned and must be a minimum 1 1/2" offset from the course above.
- DO NOT drive nail heads or staple crowns below wood surface.
- Overdriving or underdriving the fasteners can seriously damage the integrity of your roofing system.

- Different climates have different code requirements. Ensure the right products and installation methods are used per the building code official in your area.
- Type of fastener used is critically important. DO NOT use electrogalvanized fasteners. Ring shank nails are used for better withdrawal resistance and in designated high wind zone areas. Read this manual for further details.
- Recommended felt types are No. 30 ASTM D226 Type II or No. 30 ASTM D4869 Type IV roofing felt. It is important that felts are asphalt-saturated - certain code approvals can be misleading regarding felt content, so check with your supplier.
- Always use a permeable underlayment. There is no performance data available for cedar shake and shingle products over synthetic underlayment (over 80 different synthetic underlayments exist). If you elect to use a synthetic underlayment, and have local building code official approval, be sure that it is permeable and resistant to clogging from fine particles, dust and resins.

Sheathing

Shakes and shingles may be applied over spaced sheathing. Spaced sheathing is usually 1 x 4 or 1 x 6 softwood boards and shall not be less than 1 x 4 boards.

Solid sheathing is recommended for shakes and may be required in seismic regions or beneath treated shakes and shingles. Solid sheathing is used in areas with wind-driven snow. **Please note that the only solid sheet sheathing tested with Certi-label® shakes and shingles is plywood. Check with your local building official for plywood thickness/dimensions.** Eave protection is used on the edge where 36" felt underlay is used and should extend up 24" beyond the exterior wall but it is not meant to cover the entire roof.

Recommended felt types are No. 30 ASTM D226 Type II or No. 30 ASTM D4869 Type IV roofing felt. It is important that felts are asphalt-saturated - certain code approvals can be misleading regarding felt content, so check with your supplier.

Staggered Butt Applications

Staggered butt applications are made by shortening the exposure less than the greater maximum exposure. No shakes or shingles shall be applied greater than the maximum exposure allowed. Check with local building codes for approval of this installation method.

Note: Do not cover the entire deck with non-permeable barrier (including non-permeable underlayment). See CSSB technical bulletin "Asphalt-Saturated Organic Felt".

The CSSB recommends installing over plywood panel or dimensional lumber sheathing. If other sheathing materials are approved for use by your local building code official, the holding power of the fasteners should also be considered carefully. Contact local building code official for substrate (plywood) attachment fastener detail.

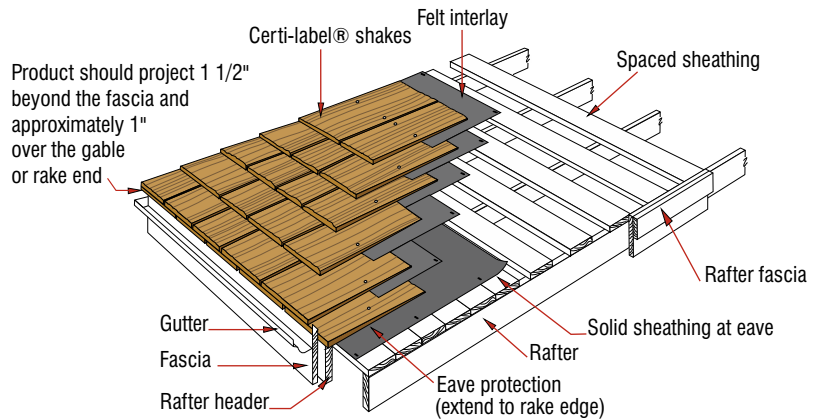

Figure 1: Spaced Sheathing

For applications using varied exposures, the center of the sheathing board should be equal to the distance of the exposure.

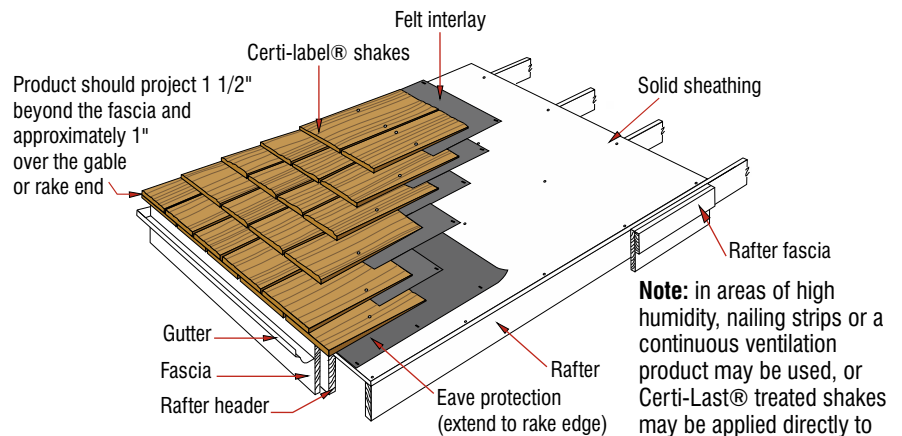

Figure 2: Solid Sheathing

Note: in areas of high humidity, nailing strips or a continuous ventilation product may be used, or Certi-Last® treated shakes may be applied directly to the deck.

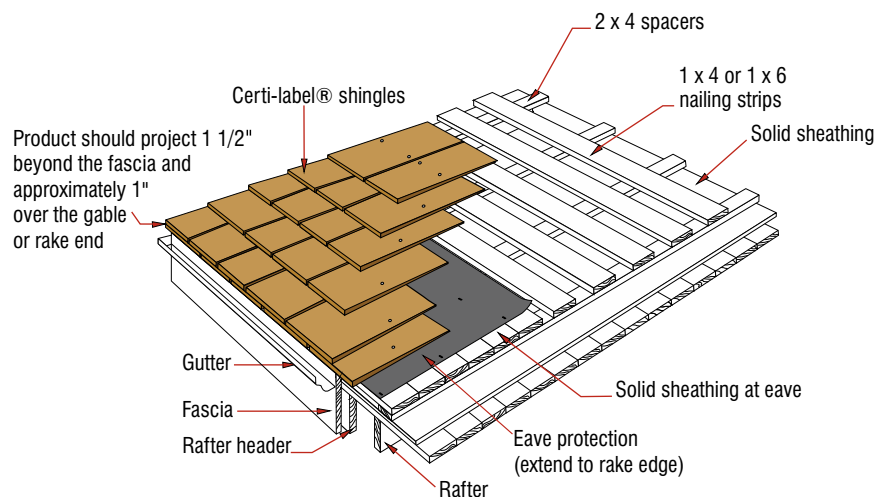

Figure 3: Spaced Over Solid Combination Sheathing

This is the preferred system for shake and shingle application, in areas with high humidity or where additional ventilation is required. When using Certi-Last® products, they may be applied directly to the deck. **Note:** Figure 3 shows shingle application, shakes require felt interlay.

Certi-label® Shakes

A solid deck is recommended in seismic activity, hurricane and tornado regions and in areas where wind-driven snow is encountered. Roofing felt system interlay between the shake courses is required whether the sheathing is spaced or solid. The felt interlay acts as a baffle that prevents wind-driven snow or other foreign material from entering the attic cavity during extreme weather conditions. The felt interlays also increase the roof's insulation value. The felt interlay system forces water to the surface.

If spaced sheathing is used in shake application, the sheathing is usually 1 x 6 boards spaced on centers equal to the weather exposure, at which the shakes are to be laid - but never more than 7 1/2" for 18" shakes and 10" for 24" shakes on roof installations. When 1 x 4 spaced sheathing is installed at 10" on center, additional 1 x 4 boards must be installed (i.e. maximum allowable spacing is approximately 3 1/2" measured from edge to edge between the sheathing boards). Please note that the only solid sheet sheathing tested with Certi-label® shakes & shingles is plywood. Check with your local building official for plywood thickness/dimensions.

Special care should be taken when installing the felt interlays over spaced sheathing to ensure that an effective baffle is formed (Figure 1). The felt should be applied over the top portion of the shakes and extend on to the spaced sheathing so that the bottom edge of the felt is positioned at a distance above the butt equal to twice the weather exposure.

Notes:

- See pages 20-21 for high humidity area details
- Currently the only acceptable solid sheathing product tested for use with Certi-label® shakes is plywood.

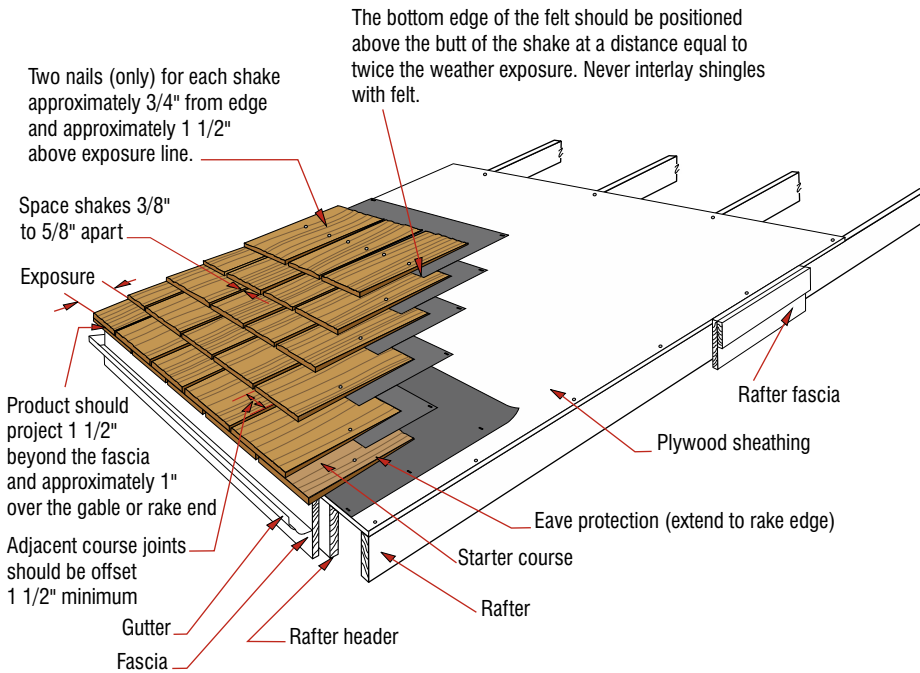

Figure 4: Certi-label® Shake Application

Certi-label® Shake Application

Shakes, like shingles, are normally applied in straight, single courses. The following application details (Figure 4) must be observed.

1. The starter course may be one or two layers of cedar shingles or shakes overlaid with the desired shake. A 15" shake is made expressly for starter and finish courses.
2. Butts of first course shakes should project 1 1/2" beyond the fascia and approximately 1" over the gable or rake end.
3. The CSSB recommends using an 18" wide strip of No. 30 ASTM D226 Type II or No. 30 ASTM D4869 Type IV roofing felt laid over the top portion of shakes and extending on to the sheathing. (Check with your local building code official for exact specifications in your area). The bottom

edge of the felt should be positioned above the butt of the shake at a distance equal to twice the weather exposure. For example, 24" shakes, felt extends up 14" onto the sheathing forcing water to the surface.

4. Spacing between adjacent shakes should be a minimum of 3/8" and a maximum of 5/8".
5. Shakes shall be laid with a side lap of not less than 1 1/2" between joints in adjacent courses.
6. Straight-split shakes should be laid with the froe-end (the end from which the shake has been split and which is smoother) towards the ridge.

Certi-label® Shingles

There are two acceptable methods for application of spaced sheathing: One is to space 1 x 4 boards to coincide with the weather exposure (Table 2, Page 24) of the shingles (Figure 5). Thus, if the shingles are to be laid at 5 1/2" to the weather, the sheathing boards would also be spaced at 5 1/2" on center. In this method of application each shingle is nailed to the center of the 1 x 4 board. With 7 1/2" weather exposures, the center of the sheathing board shall equal the distance of the weather exposure.

Alternatively, although not commonly used, a permeable underlayment (i.e. breathable), such as roofing felt, may be applied over either solid or spaced sheathing.

Note: The only solid sheathing product tested for use with Certi-label® shakes and shingles is plywood. Check with your local building code official for plywood thickness/dimensions.

For 4:12 slope and steeper, use Number 1 Grade shingles at 5", 5 1/2" and 7 1/2" exposures for 16", 18" and 24" shingles respectively. For lower roof slopes and lower product grades use reduced exposures.

Two nails (only) for each shingle approximately 3/4" from edge and approximately 1 1/2" above exposure line.

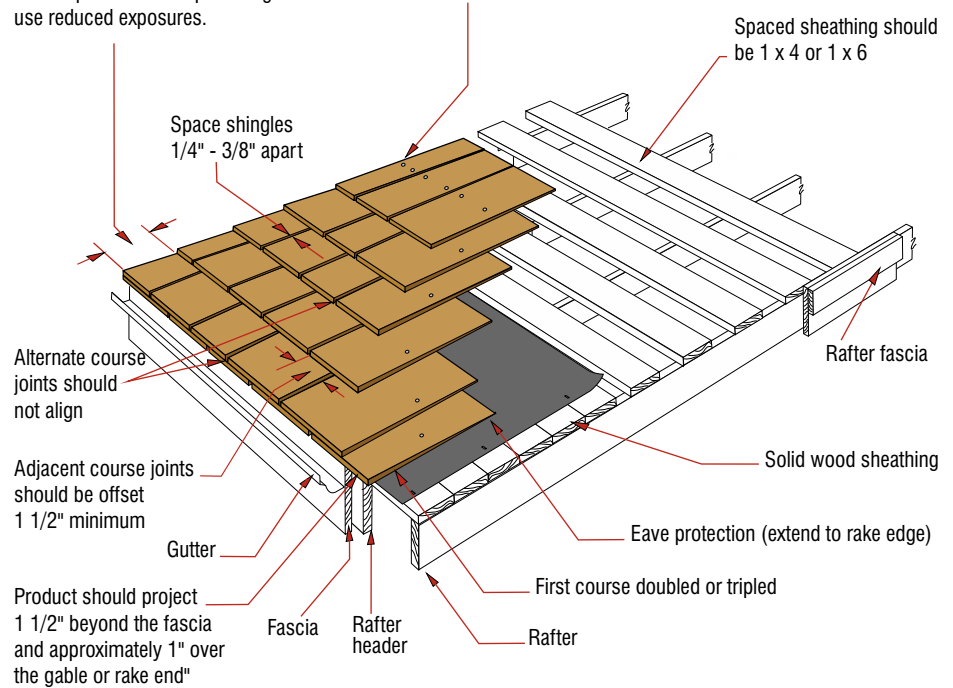

Figure 5: Certi-label® Shingle Application

Certi-label® Shingle Application

Regardless of style, the following basic application details (Figure 5) must be observed.

1. Shingles must be doubled or tripled at all eaves.
2. Butts of first course shingles should project 1 1/2" beyond the fascia and approximately 1" over the gable or rake end.
3. Spacing between adjacent shingles (joints) should be a minimum of 1/4" and a maximum of 3/8".
4. Certi-label® shingles shall be laid with a side lap not less than 1 1/2" between joints in adjacent courses, and not more than 10% shall be in direct alignment in alternate courses. Check with your local building code official in your area.
5. In lesser grade shingles (Figure 5a) containing both flat and vertical grain, joints should not be aligned with centerline of heart.

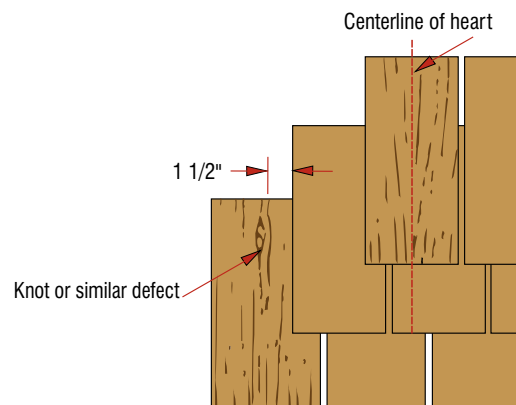

Figure 5a: Course Alignment

6. Flat grain shingles wider than 8" should be split in two before nailing. Knots and similar defects should be treated as the edge of the shingle and the joint in the course above placed 1 1/2" from the edge of the defect.

The mansard is particularly well suited to renovation work on pitched roof houses because the upper story can be enlarged without adding extra height to the structure.

The low downward slope of the mansard roof line acts visually to reduce the scale of a building and helps to eliminate a boxy appearance. This technique is used frequently on large commercial projects, particularly those near residential neighborhoods. It is also a common solution to the problem of avoiding a monotonous appearance on flat-roofed frame apartment buildings.

Properly used, a mansard roof can strengthen the design without substantially increasing construction costs. If raised up above the level of a built-up roof the mansard can screen out roof penetrations or mechanical equipment.

The variety of mansard roofs is practically infinite. One of the most widely used (and misused) roof designs, its proportions and scale are very important and care should be taken to avoid a mansard roof line that is either too skimpy or too generous.

Two of the most widely used roofing materials on the mansard roof are Certi-label® cedar shakes and shingles. Cedar shakes, with their heavier texture and solid appearance, are perhaps more frequently specified for mansards although shingles are also used, particularly when a lighter scale is desired.

The light weight and ease of application of Certi-label® shakes and shingles contribute substantially to economical construction.

Construction details for typical mansard roofs are shown in Figure 6.

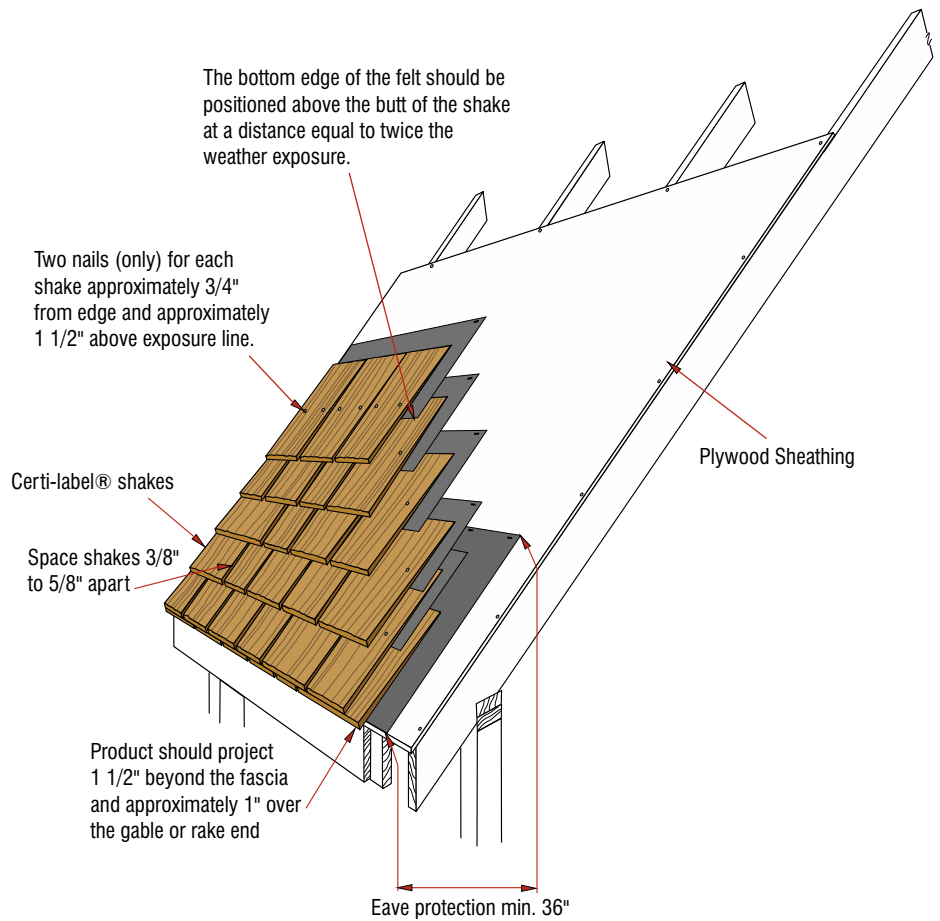

Figure 6: Mansard Roof



Photo: Murray Levin

The minimum roof slope on which Certi-label® shakes are recommended is 4:12 and for Certi-label® shingles, 3:12. It is possible, however, to apply Certi-label® shakes or shingles to solid sheathed roofs of low slope between 3:12 and 4:12. Certi-Last® pressure-impregnated preservative-treated shakes or shingles are recommended in low slope installations. Shingles must be applied at a reduced exposure. Never interlay shingles with felt. The prescribed method provides a double roof on which the Certi-label® shakes or shingles are applied to a lattice-like framework embedded in a bituminous surface coating.

A hot mop or similar approved membrane should be applied over the roof deck. Consult your local building code official for approved products in your area. With the final hot-mop application 2 x 4 spacers of Western Red Cedar or preservative treated lumber are embedded in the bituminous coating. These spacers are installed over the rafters and extend from eave to ridge. Check with your local building code official for their preference in your area.

Next, 1 x 4 or 1 x 6 nailing strips, spaced according to the weather exposure selected for the Certi-label® shakes or shingles, should be nailed across the spacers to form a lattice-like nailing base. For example, if 24" shakes are to be installed at a weather exposure of 10", the nailing strips would also be spaced at 10" on centers. When 1 x 4 spaced sheathing is installed at 10" on center, additional 1 x 4 boards must be installed.

Finally, the Certi-label® shakes or shingles are applied in the normal manner with a starter course at the eave and felt interlay between each course of shakes (Figure 7).

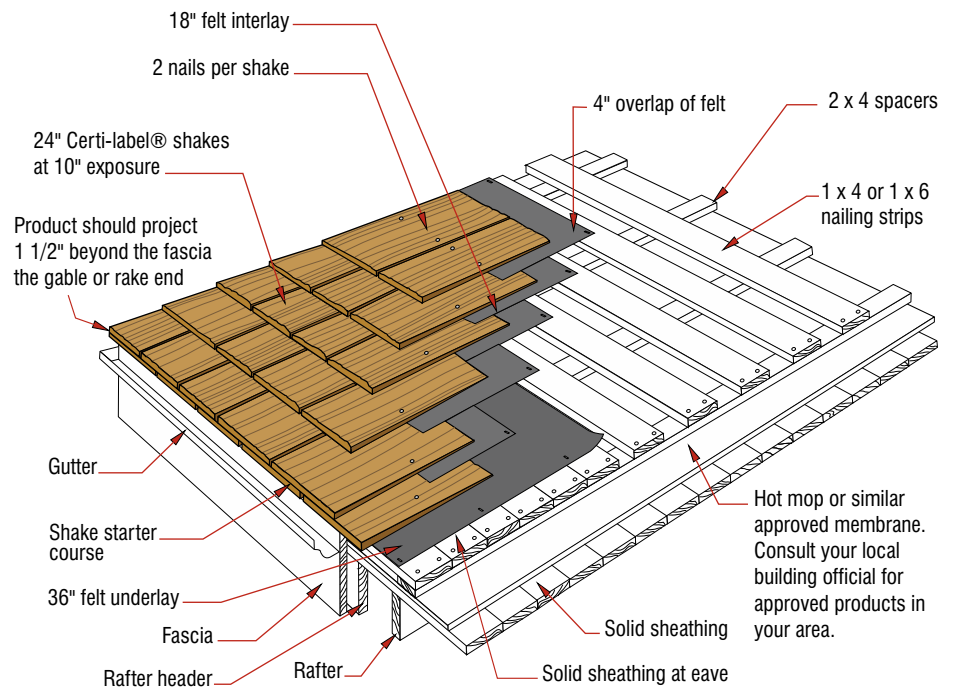

Figure 7: Certi-label® Shake Application to Low Slope Roofs

Note:

- When utilizing a non-permeable barrier (including non-permeable underlayment) over the entire roof deck/sheathing system, consult a Building Envelope Specialist.
- If installing shakes < 4:12 slope or shingles < 3:12 slope, check with your local building code official for approval to make sure the application complies with jurisdictional requirements.

Certi-label® Hip And Ridge Details

Intersecting roof surfaces at hips and ridges should be capped to ensure a weather-tight joint. Site-made or factory-assembled hip and ridge units may be used, but both types must have alternate overlaps and concealed nailing (Figure 8). When ridge cap and field product are the same length and grade, the weather exposure of the ridge cap should be the same exposure as the field product of the roof. Nails must be longer than those used on the field of the roof and of sufficient length to penetrate 3/4" into or completely through the sheathing. Position fasteners approximately 2" above exposure line. Install a strip of felt, eave protection material or metal over hip or ridge under the ridge or hip cap. If longer or shorter ridge cap is used, adjust exposure accordingly.

TIPS

Note:

- Nails must be longer than those used on the field of the roof and of sufficient length to penetrate 3/4" into or completely through the sheathing.
- If making hip and ridge in the field, check warranty paperwork submission requirements.
- Face nailing is not aesthetically pleasing nor is it good for the roof system integrity.
- Ensure ridge is properly ventilated to comply with local building code requirements (check this manual for more details).

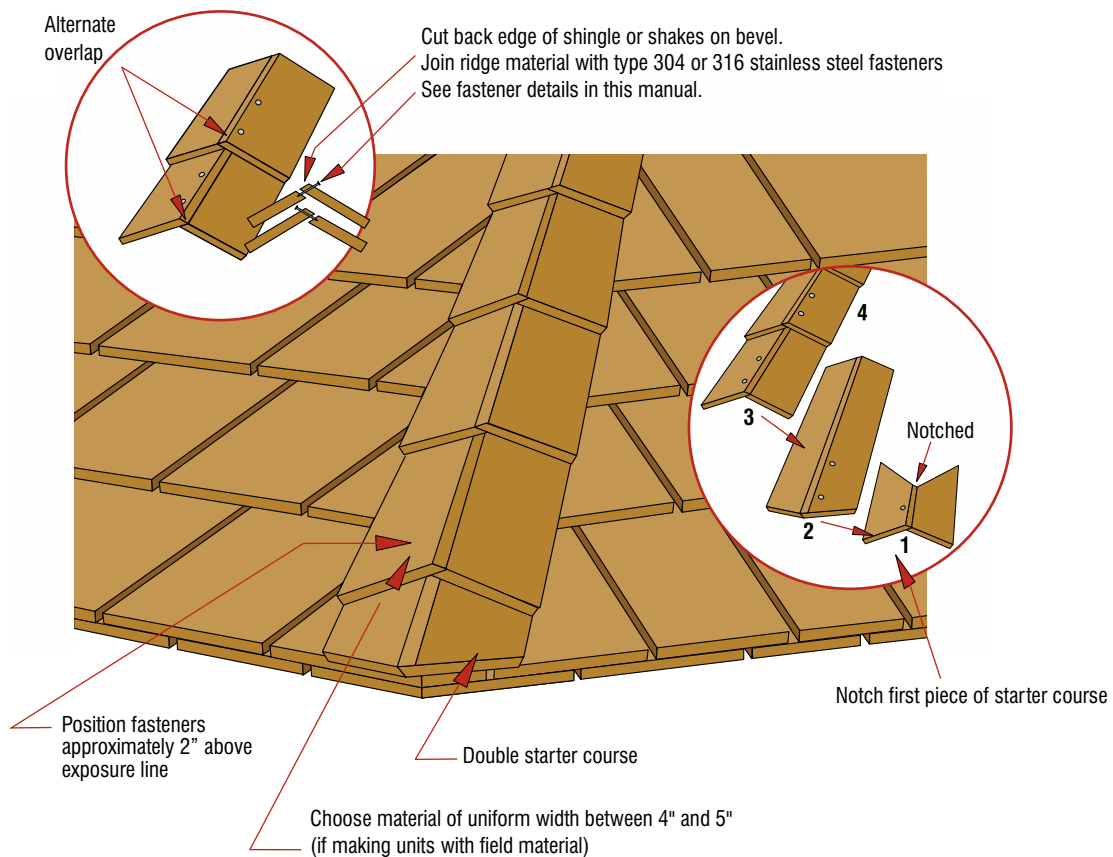

Figure 8: Certi-label® Hip and Ridge Application

Correct construction of roof junctures and slope transitions is vital to ensure the integrity of the roof system. In the following cases, where metal flashing is employed, check with your local building code official for minimum gauge/thickness requirement. It should be painted on both sides with a good metal or bituminous paint. Flashing materials should be painted after bending to maintain the integrity of the coating.

Convex Juncture

On this type of juncture (Figure 9) metal flashings should be installed to cover the top 4" of the wall and the bottom 8" of the roof slope before the final course of Certi-label® shakes or shingles is nailed to the top of the wall. A strip of wood molding can be applied after final wall course is installed. A double or triple starter course is then applied at the eave, with a 1 1/2" overhang over the outside wall trim. The roof can then be completed in the normal manner.

Concave Juncture

Metal flashings for the concave juncture are similar to those for the convex type. They should be installed to cover the top of the roof slope and the bottom 4" of the wall before the final course of Certi-label® shakes or shingles is installed. The final roof course should be installed so that the tips fit as snugly as possible against the wall at the juncture. A double starter course should be applied at the start of the wall surface and the remaining wall courses applied in the recommended manner. If nails are not acceptable through exposed metal, metal clips can be used to hold down the flashing.

Roof Transitions

Roof transitions (Figure 10) require appropriate flashing, felt and product application. Changes in roof slope should be detailed in a similar manner as concave junctures, to ensure the integrity of the roof system. Solid sheathing is required above and below the change in slope, metal flashing is required across the change in slope, and a 36" strip of starter felt is required on the upper slope, installed in the same fashion as at the eaves.

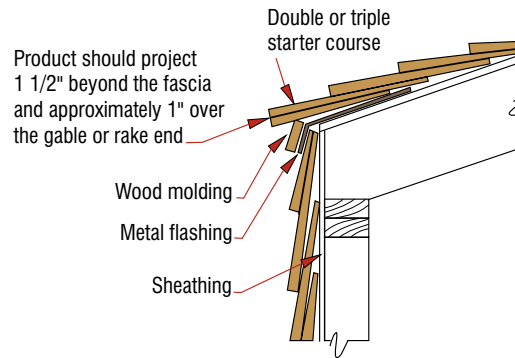

Figure 9: Convex Roof Juncture

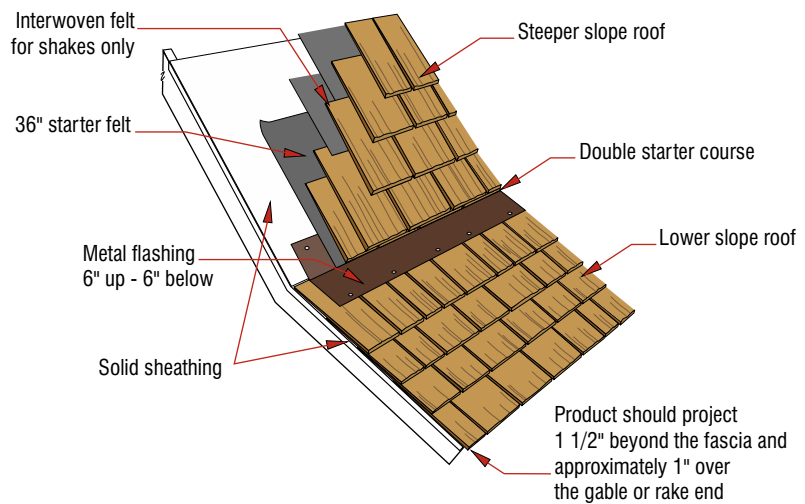

Figure 10: Low Slope to Steep Slope Roof Transition Detail - Certi-label® shakes
(Certigrade® shingle application is similar but without felt interlay)



Courtesy: Western Wood Products, Photo: John Spaulding

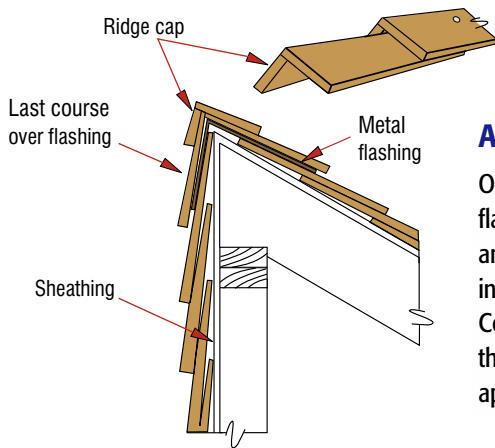

Figure 11: Apex Roof Juncture

Apex Juncture

On this roof juncture (Figure 11) metal flashing should cover the top 8" of the roof and the top 4" of the wall. It should be installed before the final course of Certi-label® shakes or shingles is applied to the wall. The recommended sequence of application is to apply Certi-label® shakes or

shingles first to the wall then to the roof. The overhanging roof material is then trimmed flush with the wall. Finally, specially prepared ridge units are applied over the wall-roof juncture so that in each matching pair the roof piece overlaps the wall piece each time.

Swept or Bell Eave

When Certi-label® shakes or shingles are to be applied to a swept or bell eave where the curvature is excessive, it may be necessary to soak them for a period (usually overnight) or steam them prior to installation. A double

starter course is employed in the usual manner. Exposure is determined by the slope of the roof and the type of Certi-label® shake or shingle selected. At lower pitches a waterproof eave protection should be used.

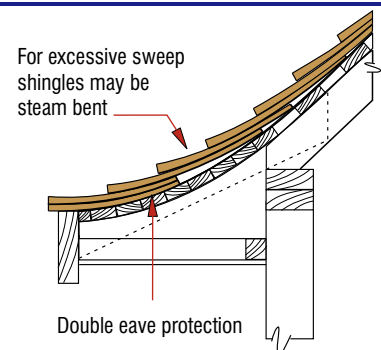

Figure 12: Swept or Bell Eave

ROOF VALLEY FLASHING DETAILS

Roof Valley Flashing Detail

Most roof leaks can occur where water is channelled off the roof or where the roof abuts a vertical wall or chimney. At these points, metal valleys and flashings are used to assist the Certi-label® shakes and shingles in keeping the structure sound and dry.

Structural members that join a roof should also be flashed at all intersecting angles to prevent leakage. Step flashing should extend under the Certi-label® shakes and shingles, up the vertical surface, (one flashing installed on each course concealed under the covering course) and should be covered by a second layer of flashing (counter-flashing).

Flashing should be pre-painted both sides using a good metal or bituminous paint (Figure 13a). Flashing strips which must be bent to sharp angles should be painted after bending. Metal flashing with baked-on enamel coating is available in some areas.

Different flashing metals are available in different areas depending on climatic variations. It is good practice to use metals that have proven their reliability under the specific conditions to be encountered. It is important that metal flashing have the same

longevity as Western Red Cedar. Check with your local building code official for their preference in your area. When using a pressure-impregnated treated product, contact the treatment company for metal specifications.

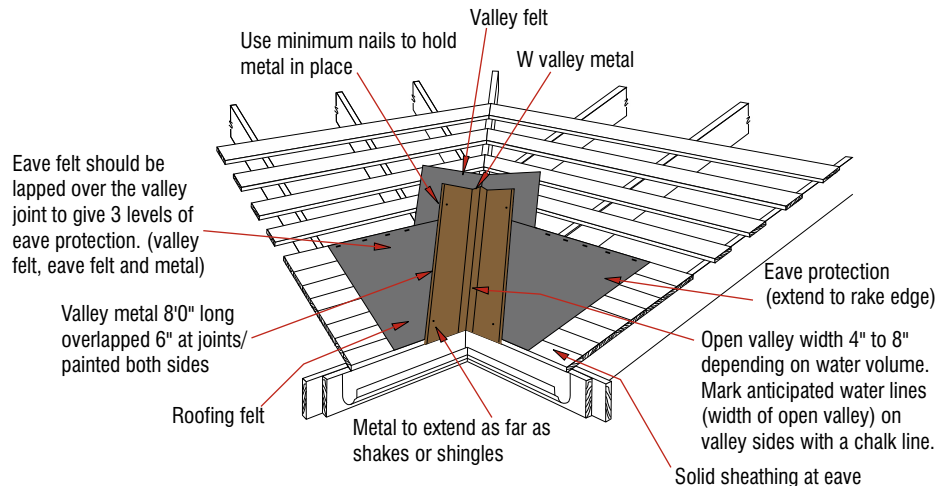

Figure 13a: Valley Metal

Valleys: Certi-label® Shingles

For roofs with slopes of 12:12 or greater, valley flashing should extend not less than 8" on each side of the valley centerline. For roof slopes less than 12:12, flashing should extend not less than 11" each side. Valley metal should be underlaid with No. 30 ASTM D226 Type II or No. 30 ASTM D4869 Type IV roofing felt. Shingles should not be applied with their grain parallel to the valley centerline and those extending into the valley should be cut at the correct angle (Figure 13b).

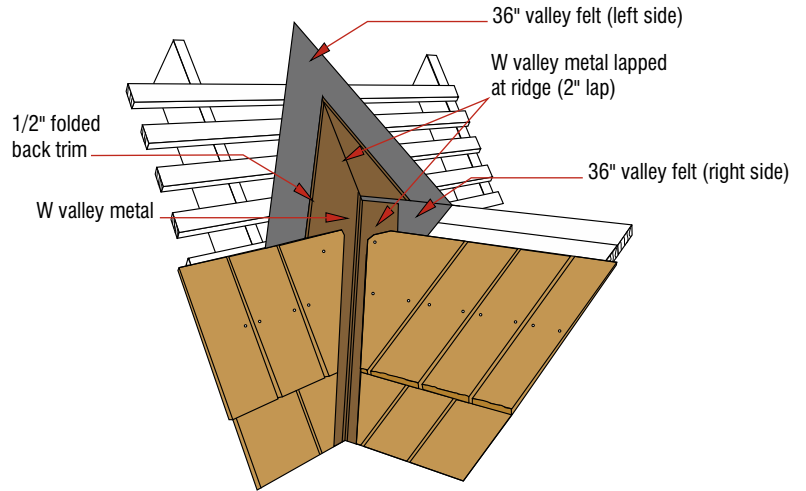

Figure 13b: Typical Saddle Flashing Detail

Valleys: Certi-label® Shakes

On shake roofs, it is recommended that a strip of No. 30 ASTM D226 Type II or No. 30 ASTM D4869 Type IV roofing felt be installed over the sheathing and under the metal valley. Metal valleys should be center-cripped, painted, galvanized steel or aluminum and should extend not less than 11" on each side of the valley centerline. In some areas, however, flashing width requirements may differ and local building codes should be consulted. Shakes should not be applied with their grain parallel to the valley centerline and those extending into the valley should be cut at the correct angle (Figure 13c).

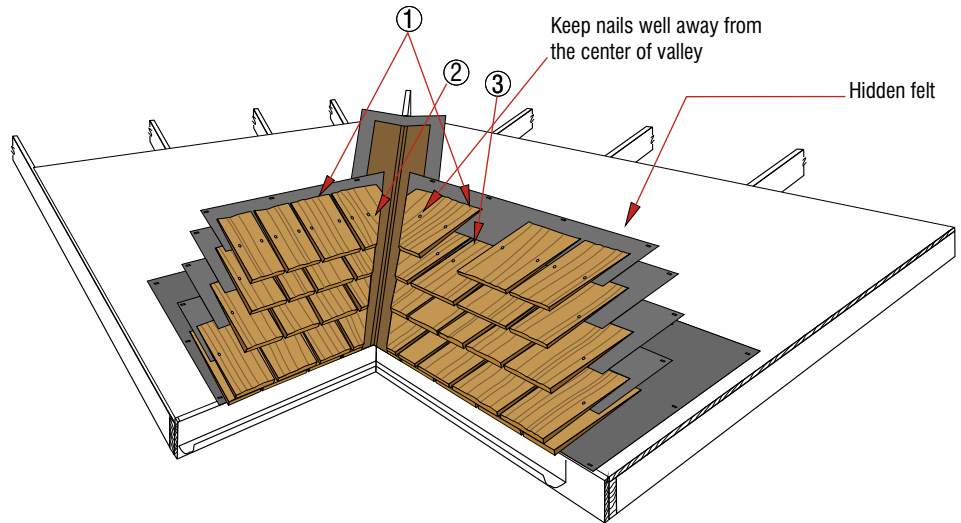

Figure 13c: Valley Product Application

Note: Check with your local building code official for minimum gauge/thickness requirement.

- Order of applying Certi-label® shakes or shingles at valley:
1. Stop course line here
 2. Place pre-cut valley piece so that cut-angle is positioned on the valley guide chalk line with tip on the course line.
 3. Select product of the required width to complete the course of Certi-label® shakes or shingles.

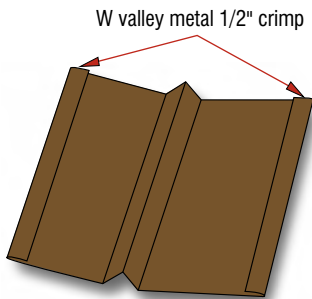

Figure 13d: Roof Valley Flashing Detail

Figures 13a-13d: Flashing Details for Shake and Shingle Valleys

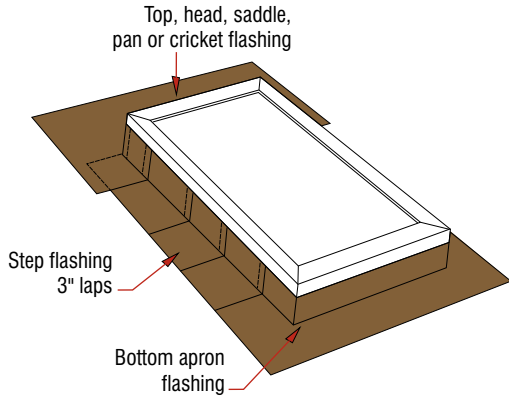

Figure 14a: Skylight Flashing

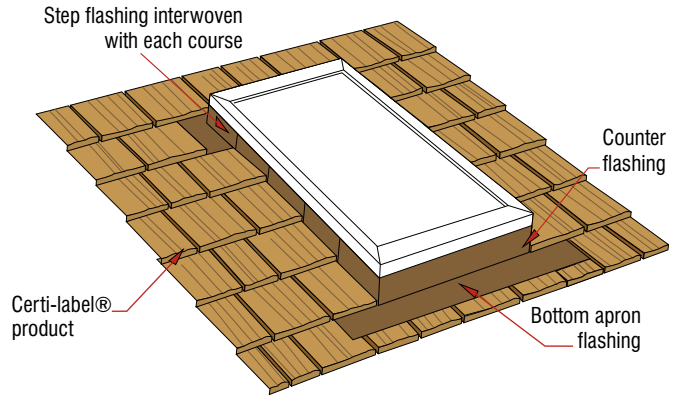

Figure 14b: Skylight Installation

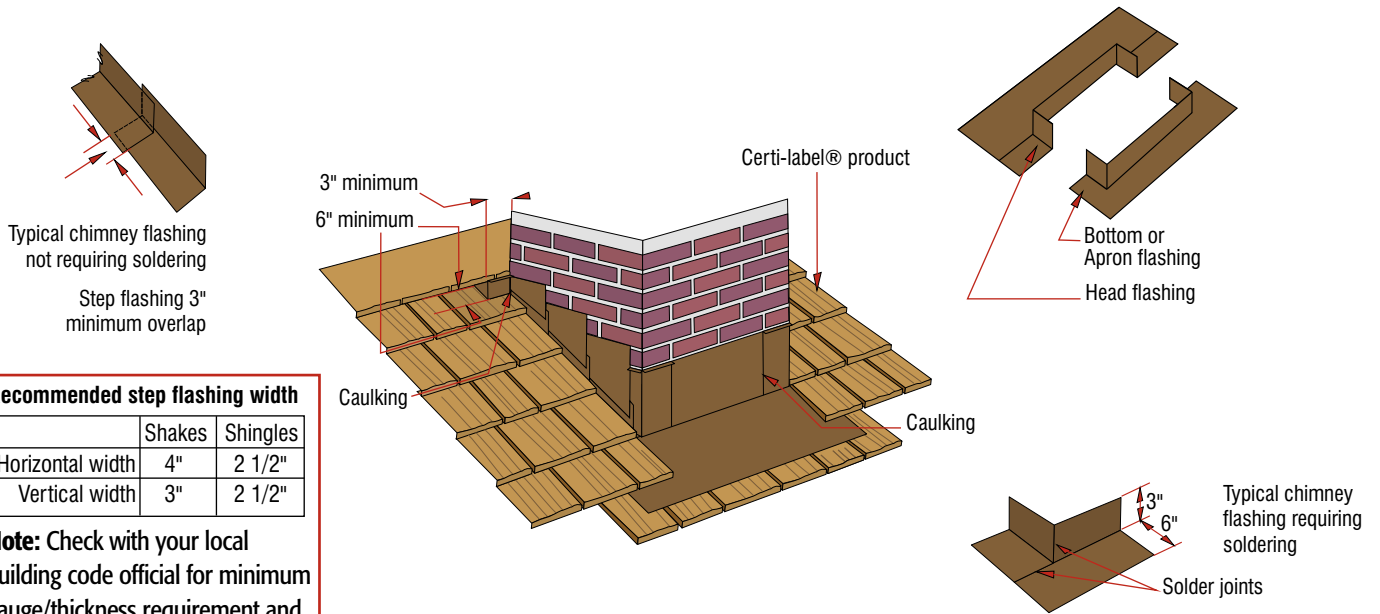

Figure 14c: Typical Projection Flashing

Recommended step flashing width

	Shakes	Shingles
Horizontal width	4"	2 1/2"
Vertical width	3"	2 1/2"

Note: Check with your local building code official for minimum gauge/thickness requirement and step-flashing height.

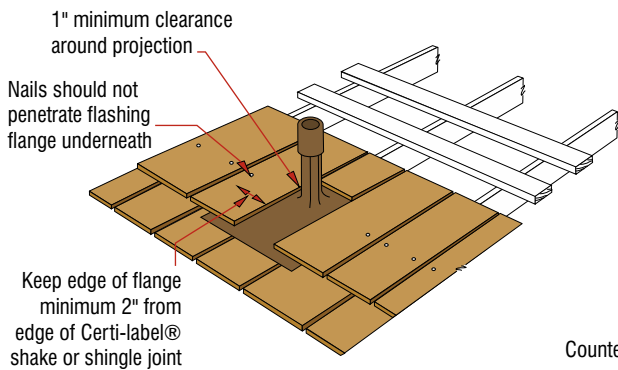

Figure 14d: Typical Projection Flashing

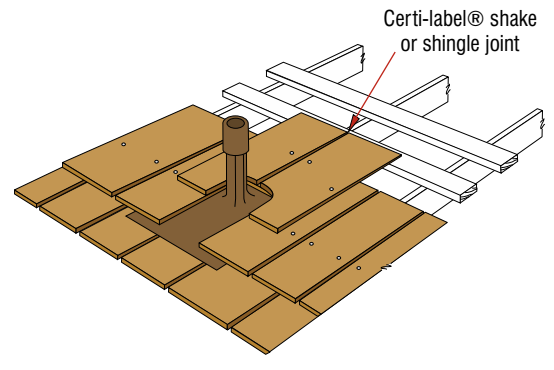
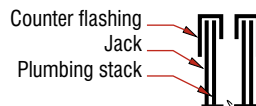

Figure 14e: Typical Projection Flashing



Figures 14a-14e: Flashing Details for Typical Roof Projections

Check with building code official for local jurisdiction requirements

Nails

Each Certi-label® shake or shingle shall be applied with two fasteners. Nails must be stainless steel Type 316 in locations within fifteen (15) miles of salt water. For locations outside the salt water zone - nails must be stainless steel, Type 304, Type 316, or hot-dipped galvanized with a coating weight of ASTM A 153 Class D (1.0 oz/ft²). Stainless steel nails offer the highest degree of corrosion resistance. Ring shank nails are used for better withdrawal resistance and in designated high wind zone areas. **Some nail manufacturers offer nails specifically for wood shake or shingle roof application. Contact the nail manufacturer for further information to ensure the fasteners used comply with listed requirements and are correct for your application.**

Staples

The Cedar Shake & Shingle Bureau® prefers the use of nails, however if you choose to use staples they must be stainless steel Type 316 in locations within fifteen (15) miles of salt water. For locations outside of the salt water zone stainless steel Type 304 or Type 316 must be used. Each Certi-label® shake or shingle shall be applied with two (2) staples. Staples must be 16 gauge with crowns 7/16" minimum horizontal, maximum 3/4" horizontal to the Certi-label® shake or shingle butt.

Fasteners	
Type of Certi-label® Shake or Shingle	Nail Type and Minimum Length
Certi-Split® & Certi-Sawn® Shakes	
18" Straight-Split	5d Box 1 3/4
18" and 24" Handsplit and Resawn	6d Box 2
24" Tapersplit	5d Box 1 3/4
18" and 24" Tapersawn	6d Box 2
Certigrade® Shingles	
16" and 18" Shingles	3d Box 1 1/4
24" Shingles	4d Box 1 1/2

Important Notes:

Underdriving or overdriving any fastener will affect the integrity of the roofing system. Fasteners utilized must be specific for use with wood shakes and shingles to prevent splitting and other weakening factors. **Do not use electrogalvanized (EG) fasteners.** Ensure the fasteners used comply with listed requirements.

Do not be fooled by "Number" 304 or 316 fasteners. The proper specification will include "Type" 304 or 316 – there is a content difference. Longer fasteners of the same quality are required for nailing hip and ridge product.

Check fastener requirements for your location (ie. salt water proximity or not.)

Nails must be stainless steel Type 316 in locations within fifteen (15) miles of salt water. For locations outside the salt water zone - nails must be stainless steel, Type 304, Type 316, or hot-dipped galvanized with a coating weight of ASTM A 153 Class D (1.0 oz/ft²).

Pressure Impregnated Treated Shakes and Shingles

Fasteners used with fire-retardant-treated (Certi-Guard®) and preservative-treated (Certi-Last®) shakes or shingles **must be** stainless steel **Type 316**. For specifics on installation, accessory building materials (flashing, etc), finishes and maintenance please contact the treatment company directly.

The information above is not intended to supersede local building codes.

Do not use electrogalvanized (EG) fasteners.

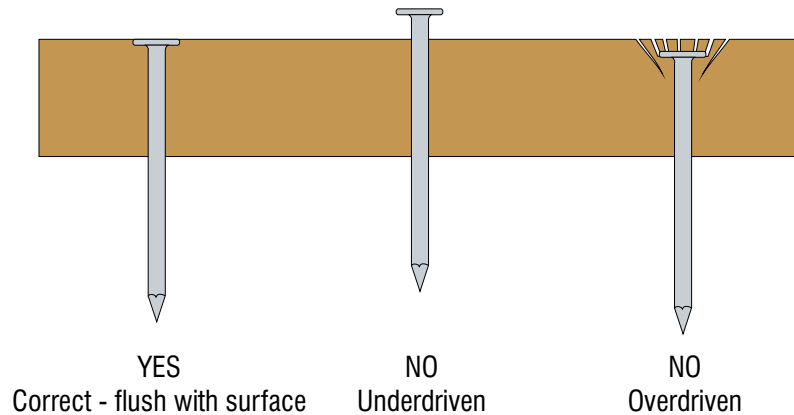

Location/Penetration

Fasteners, two (2) per shake or shingle, shall be applied approximately 3/4" from the edge and approximately 1 1/2" above the exposure line. Fasteners shall be long enough to penetrate into the sheathing at least 3/4" or all the way through. Minimum nail lengths are shown in the fastener chart. Nails and staples must be driven flush with the surface of the Certi-label® shake or shingle. Overdriving the fastener can split and/or distort the Certi-label® shake or shingle.



Example of a severely corroded electrogalvanized fastener. Ensure the correct fasteners are used. Corroded fasteners lead to serious roof system failures as well as unsightly staining.

Important Notes:

Underdriving or overdriving any fastener will affect the integrity of the roofing system. Fasteners utilized must be specific for use with wood shakes and shingles to prevent splitting and other weakening factors. **Do not use electrogalvanized (EG) fasteners.** Ensure the fasteners used comply with listed requirements.

Pressure Impregnated Treated Shakes and Shingles

Fasteners used with fire-retardant-treated (Certi-Guard®) and preservative-treated (Certi-Last®) shakes or shingles **must be** stainless steel **Type 316**. For specifics on installation, accessory building materials (flashing, etc), finishes and maintenance please contact the treatment company directly.

The information above is not intended to supersede local building codes.

Ventilation Guidelines

The importance of good attic ventilation beneath the roof cannot be overemphasized. Such movement of air will prevent or inhibit condensation of moisture on the undersurface of the Certi-label® shakes or shingles, or on the roof decks. Vents should be provided at the soffits (eaves) as well as at gable ends (screened to prevent ingress of insects), on roof by using attic roof ventilation or preferably the ridge lines with cross ventilation desirable. A rule of thumb for adequate ventilation is that the ratio of total net free ventilation area to the area of the attic should be not less than 1:150, with compensation made for screens over vent apertures. In the case of a balanced system a 1 square foot per 300 square feet of floor area may be adequate ventilation, for normal installation. However if a barrier system of any type is used above the roof deck the attic ventilation shall be a minimum of 1:150.

If spray foam or foam boards are required to be applied to the bottom of the solid plywood sheathing (not spaced sheathing), it is strongly recommended to consult a building envelope specialist for potential issues of condensation and ultimate biodegradation of the solid plywood sheathing.

Check with your local building code official. Attic fans may be beneficial by supplying additional movement of air in attic spaces. Several roof ventilation construction techniques are shown in Figures 15a-15c.

Any modification to the vapor barrier system or addition of a vapor barrier system should only be done after consulting with your local building code official and a building envelope specialist. In some areas, building envelope specialists are regulated by government.

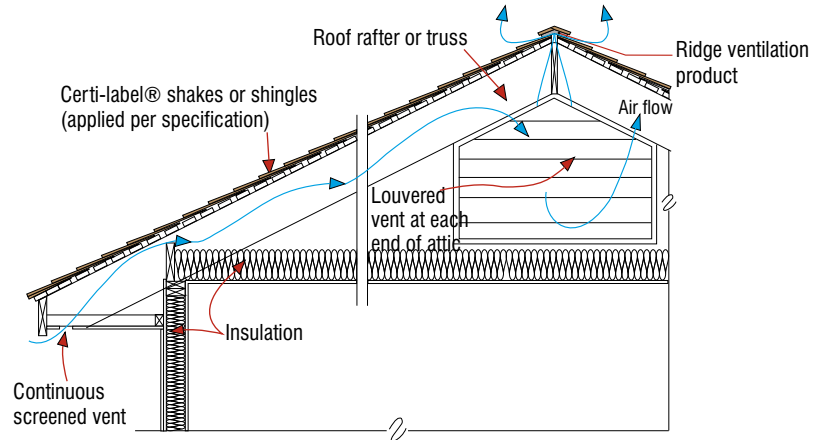

Figure 15a: Gable Roof With Attic

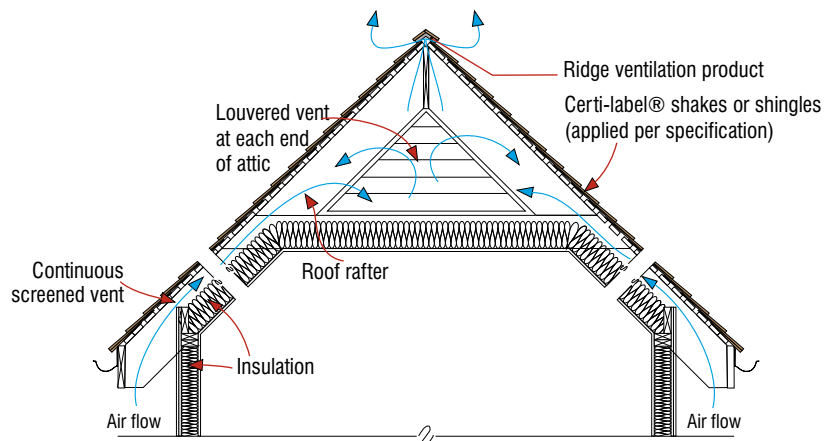

Figure 15b: Cathedral Ceiling With Partial Attic

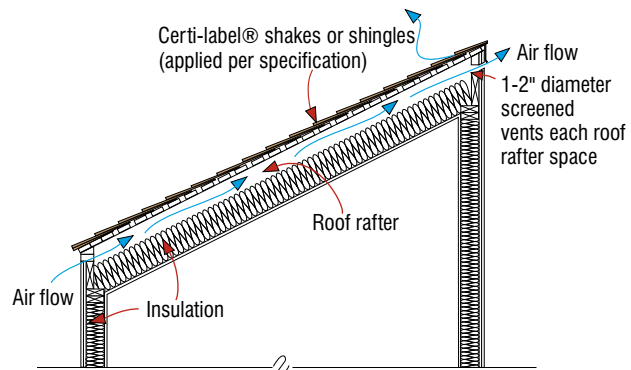

Figure 15c: Shed Roof

Figures 15a-15c: Ventilation Details

Note: Do not cover the entire deck with non-permeable barrier (including non-permeable underlayment). See CSSB technical bulletin "Asphalt-Saturated Organic Felt".

The CSSB recommends installing over plywood panel or dimensional lumber sheathing. If other sheathing materials are approved for use by your local building code official, the holding power of the fasteners should also be considered carefully. Contact local building code official for substrate (plywood) attachment fastener detail.

Ridge Vents

The amount of venting depends upon the size of the roof, roof design/structure, (attic present or not, etc.) as well as local climatic conditions. Check with your local building official for requirements in your area. One rule of thumb for venting the attic area is 1 square foot per 150 square feet of floor area. One half of this (1/2 square foot per 75 square feet of floor area) amount should be in the soffit or eave and one half (75 square feet) in the roof system. In the case of a balanced system 1 square foot per 300 square feet of floor area may be adequate ventilation. Check with your local building code official.

Low Slope (6:12 or less)

The CSSB recommends the installation of ridge ventilation product that allows for installation of pre-manufactured ridge applied over the vent material. There are many manufacturers of this design.

Steep Slope (8:12 or greater)

On steep slope roofs, the correct ridge ventilation products can actually facilitate the ease of installation of Certi-label® ridge units. Always follow the manufacturer's installation instructions. The predominant ridge material manufactured today is for a low slope roof. However, by using a ridge ventilation product that is malleable and at least 8 1/2" wide, the material can be installed across the minimum 3" of air space at the ridge to create a shallowing of the slope at the ridge. Care must be taken to caulk the ridge ventilation material to the Certi-label® shakes or shingles. Proper nailing of the ridge units will create a serviceable application.

Severe Climate Areas

In all wind driven snow areas, the proper ridge ventilation product should have a screening effect to prevent snow infiltration (not louvered or baffled).

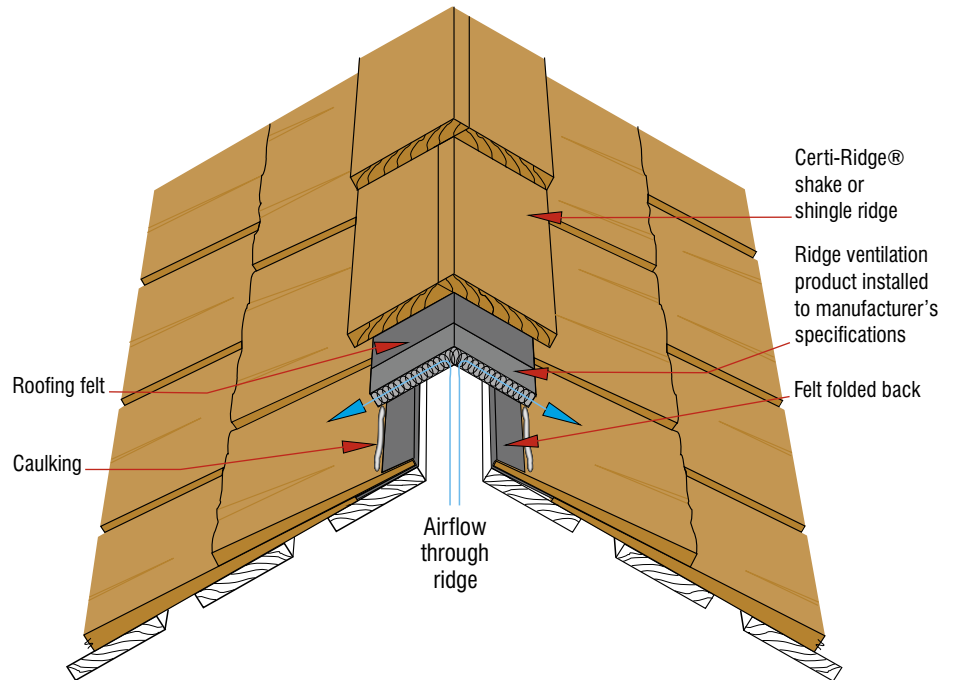

Figure 16: Ridge Ventilation Detail

TIPS

Check fastener requirement for your location (i.e. salt water proximity or not.) Nails must be stainless steel Type 316 in locations within fifteen (15) miles of salt water. For locations outside the salt water zone - nails must be stainless steel, Type 304, Type 316, or hot-dipped galvanized with a coating weight of ASTM A 153 Class D (1.0 oz/ft²).

Cedar needs to breathe. If spray foam or foam boards are required to be applied to the bottom of the solid plywood sheathing (not spaced sheathing), it is strongly recommended to consult a building envelope specialist for potential issues of condensation and ultimate biodegradation of the solid plywood sheathing.

Wood Deck

Wood decks form an ideal base over which to apply Certi-label® shakes or shingles, since they can be attached in the conventional manner.

Rigid insulation raises the issue of how to fasten Certi-label® shakes or shingles. The use of abnormally long nails driven through the Certigrade® shingles, the insulation and into the deck below is generally unsatisfactory. Horizontal strapping will be required to overcome the fastening difficulties. When strapping is used, fewer nails penetrate through the insulation to the deck, and greater thermal efficiency is achieved by reducing the number of conductors. In addition, the lengths of the nails may be chosen to prevent the points from protruding through the deck where they may mar the inside face.

If ice-damming is a potential problem or if reverse condensation is likely to occur, such as may be encountered in an ice arena, a cold roof system should be used in conjunction with horizontal strapping, and ventilation must be provided at the eaves and at the peak. In buildings such as ski cabins that may be subjected to heavy snow loads, it is usually necessary to fasten wood members (typically 2 x 4 on edge) from ridge to eave on the roof deck and place the rigid insulation between. Strapping is then applied across the top of these members, giving a ventilated air space and avoiding compression of insulation.

A false plywood deck over insulation (not shown) can be a good choice. Space the false deck over the insulation by installing 2 x 4 or greater vertical members that are securely fastened through the insulation into the rafters. Attach the plywood to the vertical members and install the cedar roof over standard underlayment.

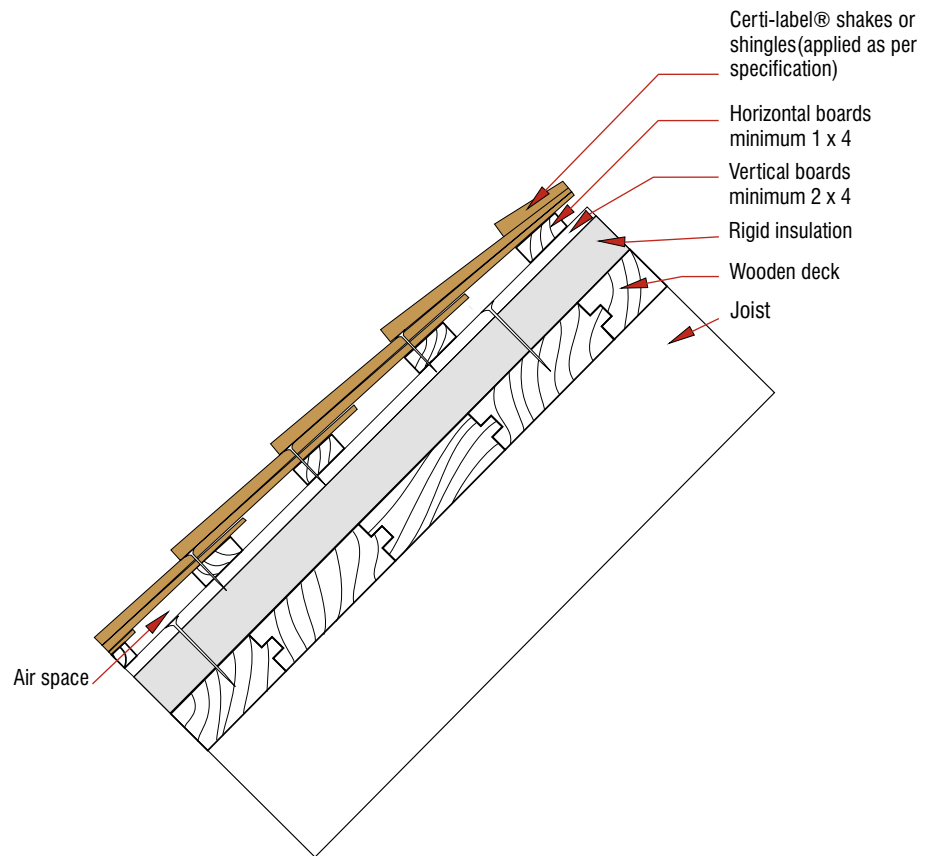

Figure 17: Specialty Roof Deck-Vented Roof

For vertical runs greater than 25 feet, contact a building envelope specialist for adequate ventilation requirements.

TIPS

- Cedar needs to breathe. If spray foam or foam boards are required to be applied to the bottom of the solid plywood sheathing (not spaced sheathing), it is strongly recommended to consult a building envelope specialist for potential issues of condensation and ultimate biodegradation of the solid plywood sheathing.
- For direct to deck application, consider using Certi-Last® products and also refer to high humidity details in this manual.
- Nails: If the Certi-label® shakes or shingles are nailed directly through rigid insulation, a number of problems may be encountered. For instance, the longer nails have thicker shanks which tend to split the Certi-label® shakes or shingles.
- Product movement may cause a reduction in insulation efficiency. For this reason, the use of strapping or a false plywood deck is again recommended.

Rigid Insulation

Numerous types of rigid insulation are now in use, and may be made from expanded polystyrene beads, rigid urethane laminate, low density fiberboard, or from fast-setting liquids poured on-site. They vary in thickness up to more than 2", as well as in length and width depending upon the manufacturer. All these types are efficient insulators and are usually of sufficient density to hold the weight of a normal roofing material without the need for lumber bridging. If you live in an area

where snowfall is prevalent, please consult your local building code official for snow load requirements. A ventilation system between the sheathing system and the bottom of the shakes or shingles is recommended when installing directly to the solid plywood deck.

If shakes or shingles are applied over insulation, ventilation is required. As a minimum, nailing strips are applied under shingles. For areas of high humidity Certi-Last® pressure-impregnated preservative-treated product is recommended.

COLD ROOF SYSTEM DETAILS

Certi-label® shakes and shingles are an excellent roofing material for cold weather areas that experience heavy snowfall and severe temperature extremes. Certi-label® shakes and shingles offer the advantages of durability, superior wind resistance and good thermal and acoustical properties. As with any other roofing material, however, their best performance depends upon proper design, sound construction practice and correct installation.

In cold weather areas and particularly in mountain regions that experience very heavy snowfall, the cold roof - or vented roof system - is recommended. The principle of this system is to allow a constant flow of cold air above the insulation but below the roofing material. With other roofing systems, ice buildup along the eaves can be a problem. Heat escapes from the insulation and melts snow, which runs down the roof to the cold overhangs where it freezes, causing water to back up and sometimes penetrate the roof systems. A properly installed, vented cold roof eliminates this problem. Venting space should be sufficient to allow a free flow of air from eave to ridge.

There are a number of important considerations that influence roof performance in areas of heavy snowfall, particularly mountain regions.

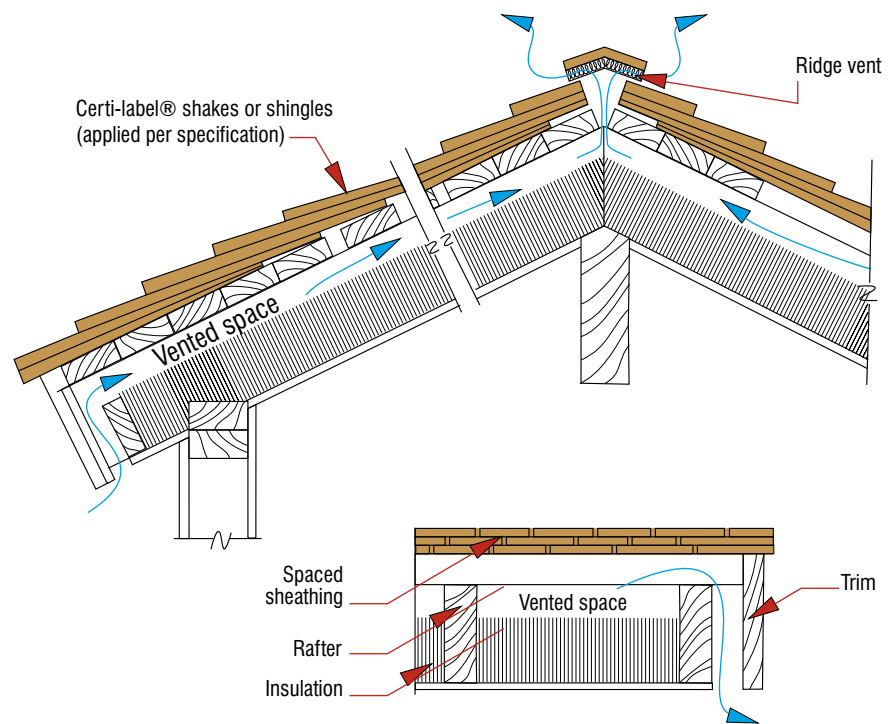

Figure 18: Gable Roof

Design, of course, is very important. The steeper the roof the better the performance. Chimneys should be located at the ridge or gable ends away from possible snow pressure on the slopes. Plumbing pipes should be located on inside walls and should be

extended between the rafters and vented at the ridge. If this is not practical then plumbing vent pipes should be galvanized iron, well anchored inside the roof. (Plastic vent pipes extending through the roof may be dislodged by sliding snow.)

Wide overhangs at the eaves should be avoided as they provide large cold areas for snow and ice build-up. A strip of metal along the eaves helps shed ice quickly. Sliding ice and snow are constant hazards and should be given primary consideration in the total building design. Outside doors should not be located at the bottom of a roof slope. Entrances and all pedestrian traffic areas are better situated beneath the gable ends of the roof.

Care must be taken in applying the sheathing boards to facilitate proper nailing. Shake or shingle side lap should be increased to 2". The entire roof must be laid with the same precautions as those taken for any other type of wood shake or shingle roof, with eave protection and an interlay felt between shakes.

Care in cold roof design and installation will result in a sound roof system giving many years of service during severe extremes of winter temperatures and snowfall.

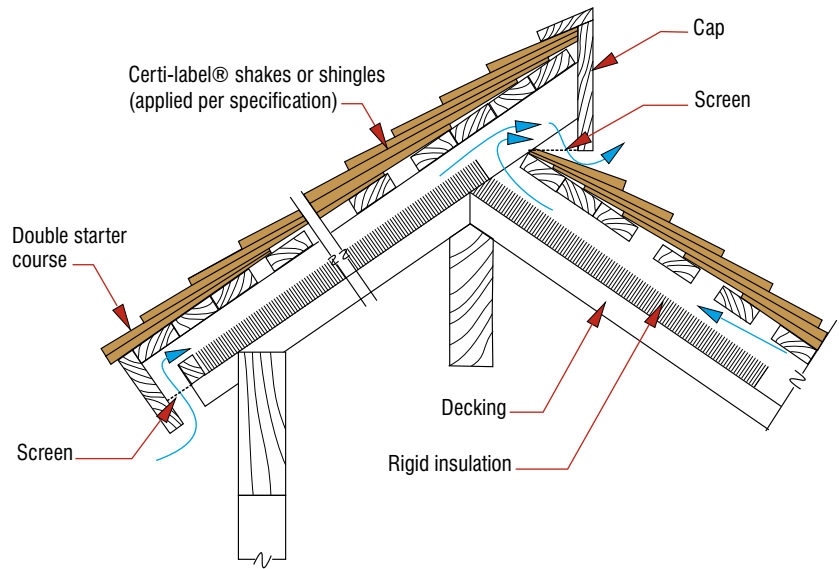

Figure 19: Shed Roof

Figures 18, 19 & 20: Cold Roof Systems

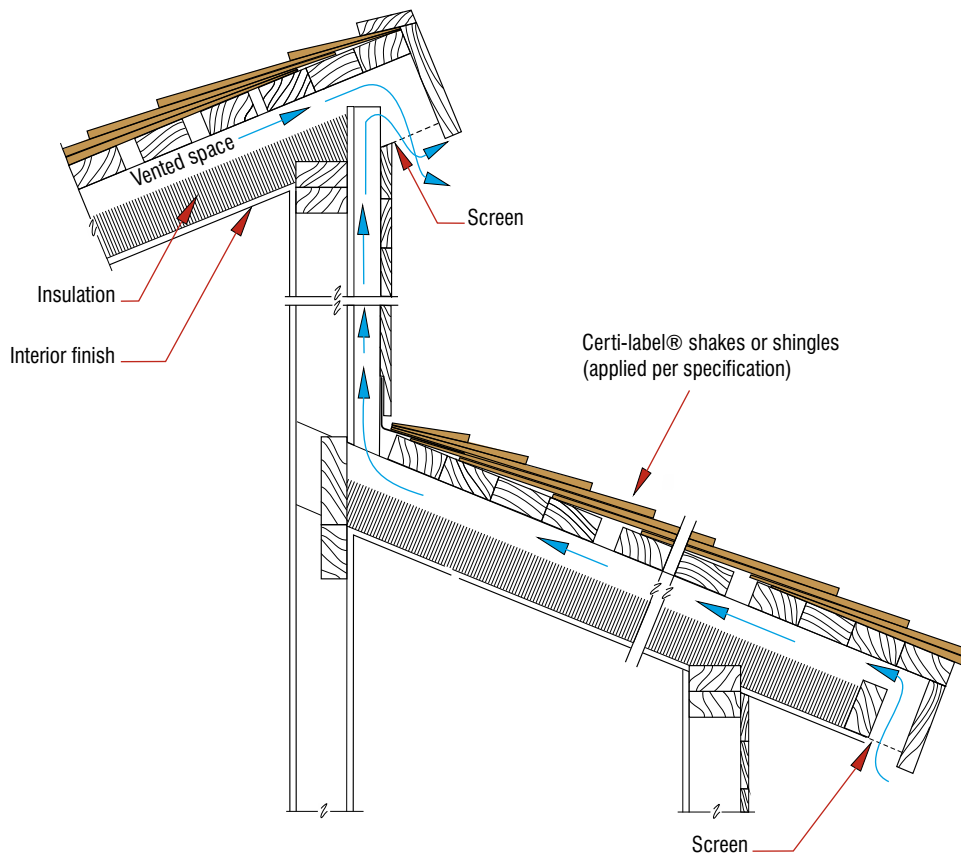

Figure 20: Half Monitor Roof

In areas of high humidity where solid sheathing is required, here are some installation options to consider:

Option 1:

Apply **Certi-Last®** pressure-impregnated treated shakes or shingles directly to the sheathing. (See Figure 21a).

Option 2:

Apply vertical strips over the sheathing in alignment with the rafters below, then place horizontal furring strips on top of the vertical boards. (See Figure 21b).

Note:
 Incorporating any type of ventilation system with Certi-Last® shakes or shingles will provide a more robust installation.
 Good ventilation is essential. Ridge and soffit vents are recommended.

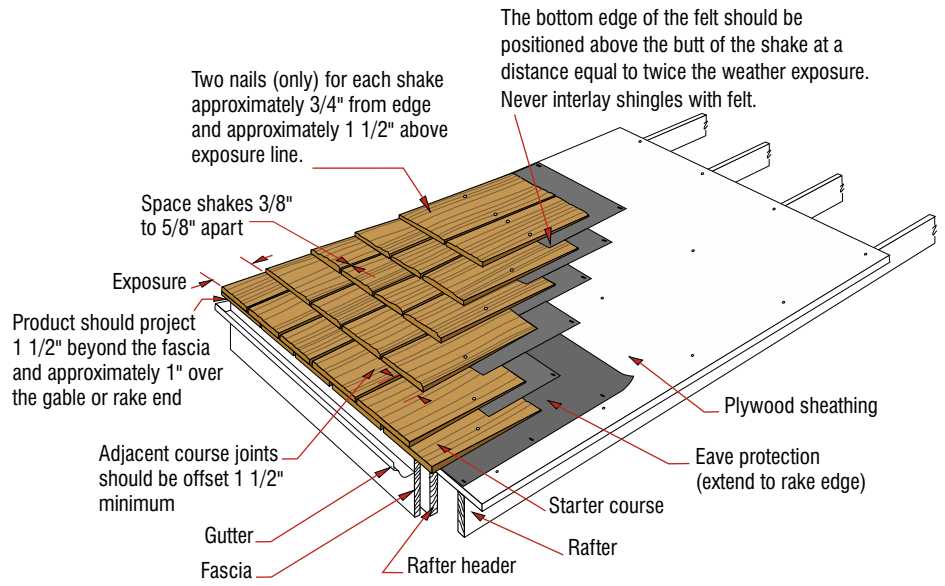

Figure 21a: Certi-Last® Shake Application (Option 1 Depicted)

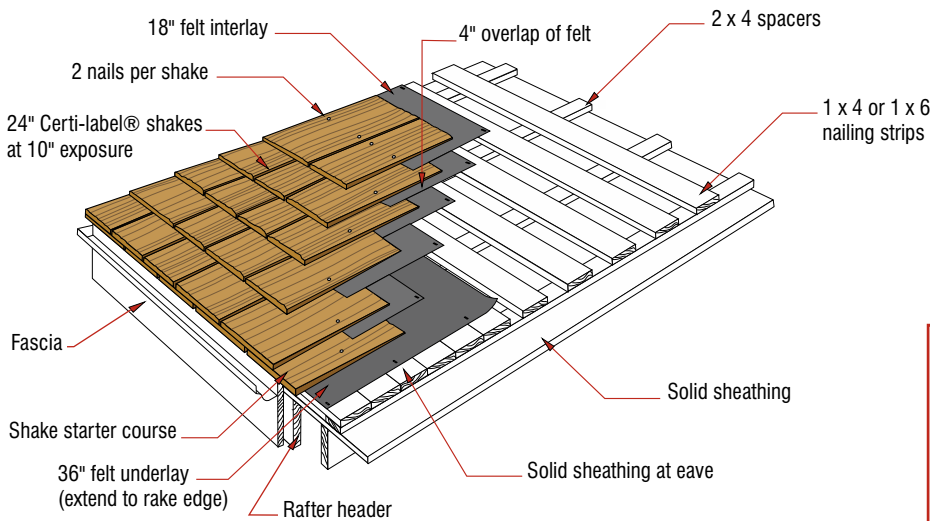

Figure 21b: Vertical Strips Over Solid Sheathing Application (Option 2 Depicted)

Note: The above figures are depicting a shake application - **Do not interlay shingles with felt.**

Option 3:

A continuous ventilation product may be used beneath the Certi-label® roofing material (See Figures 21c and 21d). The CSSB does not require the use of a continuous ventilation product: it is one of many options to consider (see previous page).

Continuous ventilation products come in a variety of designs/formats. Consult your supplier and the continuous ventilation product manufacturer for application and installation instructions specific to its product. Ask for details regarding warranty and air flow guarantee based on test results. Ask how testing was performed.

Note: Good ventilation is essential. Ridge and soffit vents are recommended.

Correct cedar shake and shingle installation practices are important and continuous ventilation products, if used, need to be part of a properly installed roofing system.

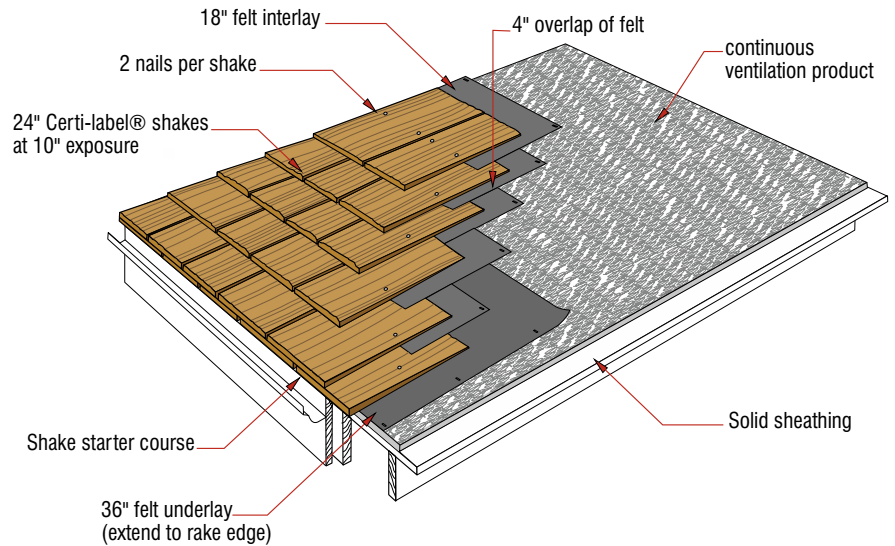

Figure 21c: Continuous Ventilation Product (mesh type)

(Option 3 Depicted)

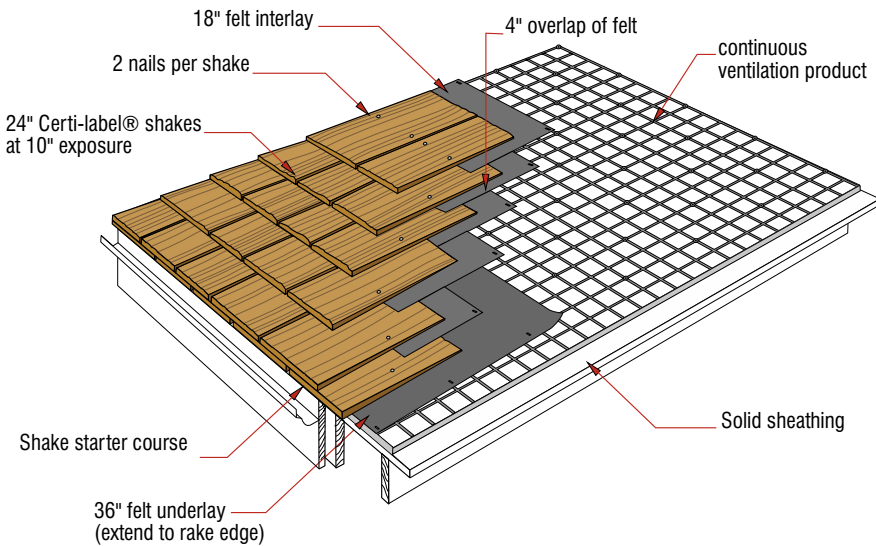

Figure 21d: Continuous Ventilation Product (rigid type)

(Option 3 Depicted)

Note: Figures 21a-d show shake application - **Do not interlay shingles with felt.**

Figures 21c - 21d: Continuous Ventilation Product Options

Certi-label® Cedar is Naturally Long-Lasting

Cedar shakes and shingles have been used for hundreds of years. They have proven their longevity in actual weather conditions, in all types of climates. Cedar shakes and shingles contain compounds that make them naturally decay resistant. Their insulative qualities, aesthetic appeal, and wind & impact resistance make Certi-label® cedar shakes and shingles the natural choice for your roofing and siding material.

Longevity Starts with a Quality Manufacturer

Not all cedar products are alike. Purchasing cedar products with the "Certi" brand name on the bundle label guarantees you that the mill undergoes inspections by an independent third party inspection agency. Only Cedar Shake & Shingle Bureau® ("CSSB") mills are allowed to label their products with the Certi-label®. Each member mill's bundles will have the distinctive Certi-label® tucked under the bundle strap. Locating Certi-label® products is as close as your nearest computer or telephone. Contact the CSSB for more information.

Longevity Continues with a Quality Installation

Roof construction plays a major role in determining the lifespan of cedar roofs. Proper design is absolutely critical to ensure long-term roof integrity. Proper installation will help maximize the life of cedar products.

Experienced care and maintenance professionals can make recommendations based on:

- Zinc or copper strips nailed at the ridge cap can be effective to control moss. Reaction between rain and the zinc or copper forms a mild solution that is carried down sections of the roof. The optional use of these strips can be eliminated if you are using Certi-Last® products.
- Overhanging branches should be kept trimmed away from the roof. This will prevent leaves, small branches and other debris from building up and keeping the roof wet.
- Gutters and downspouts need to be cleaned regularly, usually in the spring and fall. Downspouts (leaders) should run directly to the ground or to another gutter below. Never let a downspout drain directly onto a lower roof surface.
- Ensure ventilation is available, year round. Areas with louvers, ridge vents, roof vents, and soffit vents need to be kept clear and never blocked off. Adequate ventilation ensures heat and moisture do not build up in the attic area. Adequate ventilation also prevents water from accumulating at the bottom of the roof and then freezing (ice damming).

Certi-label® Cedar is also Available with Pressure-Impregnated Treatment Process

For even longer life span, where climate is a factor, CSSB members offer Certi-Last® preservative-treated shakes and shingles. These products are ideal for areas of high humidity.

Certi-Last® products are cedar shakes and shingles that are factory pressure-impregnated treated by quality treaters who are members of the CSSB. Contact the treatment company for warranty details.

Pressure-impregnated treated Certi-Guard® or Certi-Last® products should not receive after-market roof treatments without written permission from the manufacturer of such products.

Note: ONLY experienced professionals who follow proper safety and workmanship practices should implement the information contained herein.

Additional information on Care and Maintenance can be found at www.cedarbureau.org

A Word About Topical Treatments For Installed Roofs

There are hundreds of companies offering topical roof spraying and cleaning services. The CSSB has conducted an in-depth study of care and maintenance systems, and provides the following summary:

- Avoid the fly-by-night operation that has no permanent office, no workmanship guarantee, and no local references. Fly-by-night operations often gouge consumers for thousands of dollars beyond the value of their service, leaving them with damaged roofs covered with unsuitable and sometimes dangerous treatment products.

If you elect to have a topical treatment applied to your cedar roof, the CSSB recommends the following:

1. Check references (consumer, Better Business Bureau, Chamber of Commerce).
2. Ask about the treatment product that is being used (more details follow).
3. Ask to see the company's workmanship guarantee, license and workers' compensation coverage.

Note: ONLY experienced professionals who follow proper safety and workmanship practices should implement the information contained herein.

Topical Treatment Products

It is not within the CSSB's mandate to recommend brand names of topical roof treatment products. Consult with your local professionals for product information regarding cleaning and preserving cedar in your area. The CSSB does, however, recommend the following:

DO use a topical treatment product that:

- Offers a MSDS (Material Safety Data Sheet that lists product ingredients and safety precautions)
- Is labeled as a cedar roof treatment product or has a letter from the manufacturer stating that treating cedar roofs is an appropriate use for this product
- Is a water repellent, UV inhibitor, and/or EPA registered wood preservative
- Has a manufacturer's performance guarantee

DO NOT use a topical treatment product that:

- Makes outrageous claims (such as a 10-year effectiveness)
- Makes fire-retardant claims
- Is a sealant, waterproofer or plasticizer
- Contains unfortified linseed oil, diesel fuel or crank case oil

The CSSB is aware of numerous bleaching and cleaning agents. Consumers are advised to heed the preceding topical treatment precautions before allowing such products to be applied to a cedar roof.

Powerwashing

This is the most controversial issue in the care and maintenance industry. It is a fact that high pressure washing by inexperienced people will cause significant damage to any material. Some debris can easily be removed with garden hose pressure. Some contractors powerwash to clean roofs, while others do not. If powerwashing is used, the roof should receive a topical treatment to restore the roof. The CSSB recommends having a professional assess each job on an individual basis to determine if powerwashing is appropriate or not. Care and maintenance professionals know the proper procedures, which include factoring in:

- Age, condition and environment of roof
- Gallons sprayed per minute
- Fan tip size
- Distance spray nozzle is held from roof
- Pressure per square inch and others...

The Beauty Of Cedar

Another good thing about cedar is that it is possible to replace and repair parts of the roof, without worrying that your replacement shakes or shingles are significantly different in composition from your original shakes or shingles. Over the hundreds of years that cedar has been used, the product has remained unchanged...it's still cedar. As cedar advances to its mature stage, it is natural to expect some pieces to require replacement. Individual repairs are possible, and with prompt attention, proactive repairs can extend the life of your wise Certi-label® cedar investment.

Additional information on Care and Maintenance can be found at www.cedarbureau.org

Shingle Coverage Table 1									
LENGTH AND THICKNESS	Approximate coverage of one square (4 bundles) of shingles based on following weather exposures								
	3 1/2"	4"	4 1/2"	5"	5 1/2"	6"	6 1/2"	7"	7 1/2"
16" x 5/2"	70	80	90	100*					
18" x 5/2 1/4"		72 1/2	81 1/2	90 1/2	100*				
24" x 4/2"					73 1/2	80	86 1/2	93	100*

NOTE: * Maximum exposure recommended for roofs.

Shingle Exposure Table 2									
SLOPE	Maximum exposure recommended for roofs								
	LENGTH								
	Number 1 Blue Label			Number 2 Red Label			Number 3 Black Label		
	16"	18"	24"	16"	18"	24"	16"	18"	24"
3:12 to 4:12	3 3/4"	4 1/4"	5 3/4"	3 1/2"	4"	5 1/2"	3"	3 1/2"	5"
4:12 and steeper	5"	5 1/2"	7 1/2"	4"	4 1/2"	6 1/2"	3 1/2"	4"	5 1/2"

Shake Coverage Table 3 see footnote (f) below					
SHAKE TYPE, LENGTH AND THICKNESS	Approximate coverage (in sq. ft.) of one square, when shakes are applied with an average 1/2" spacing, at following weather exposures, in inches (d):				
	5	5 1/2	7 1/2	8 1/2	10
18" x 1/2" Handsplit-and-Resawn Mediums (a)*	–	75(b,f)	100(f,c)	–	–
18" x 3/4" Handsplit-and-Resawn Heavies (a)*	–	75(b,f)	100(f,c)	–	–
18" x 5/8" Tapersawn*	–	Approx. 75(b)	100(f,c)	–	–
24" x 3/8" Handsplit	–	–	75(e)	–	–
24" x 1/2" Handsplit-and-Resawn Mediums	–	–	75(b)	85	100(c)
24" x 3/4" Handsplit-and-Resawn Heavies	–	–	75(b)	85	100(c)
24" x 5/8" Tapersawn	–	–	75(b)	85	100(c)
24" x 1/2" Tapersplit	–	–	75(b)	85	100(c)
18" x 3/8" Straight-Split	–	65(b)	90(c)	–	–
24" x 3/8" Straight-Split	–	–	75(b)	85	100(c)
15" Starter-Finish course	Use supplementary with shakes applied not over 10" weather exposure.				

(a) 5 bundles will cover 100 sq. ft. roof area when used as starter-finish course at 10" weather exposure; 7 bundles will cover 100 sq. ft. roof area at 7 1/2" weather exposure; see footnote (d).

(b) Maximum recommended weather exposure for 3-ply roof construction.

(c) Maximum recommended weather exposure for 2-ply roof construction.

(d) All coverage based on an average 1/2" spacing between shakes.

(e) Maximum recommended weather exposure.

*100 sq. ft. coverage is based on 12/12 pack, 5 bundle square, at 7 1/2" exposure.

(f) Note: While most shakes are packed in bundles of 12 courses each side (12/12) they may be packed 9/9. This will alter the number of bundles required to cover 1 square.

For example: 18" shake bundles 12/12 should cover 100 square feet at 7 1/2" exposure. 9/9 pack should give 75% coverage of a square. Check with your supplier to confirm specific packaging (bundle size) used for your order.

Shake Exposure Table 4	
SLOPE	Maximum exposure recommended for roofs
	LENGTH
	18" 24"
4:12 and steeper	7 1/2" 10" (a)

(a) 24" x 3/8" handsplit shakes limited to 7 1/2" maximum weather exposure per International Building Code and International Residential Code.

Formula for calculating material at reduced exposures: Square footage divided by reduced coverage = total material required e.g. you are estimating a roof that measures 3200 square feet (32 squares). You have decided to put 16" Certigrade® shingles (No.1 Blue Label or No. 2 Red Label) at 4" exposure. The above coverage table (Table 1) tells you that a 4-bundle square at 4" exposure covers 80 square feet. 3200 divided by 80 = 40 squares of material

This information has been designed to aid architects, consultants and builders in specifying Certi-label® shakes and shingles. It suggests a standardized terminology and style for ordering in the hope of improving accuracy. It incorporates a general outline of the latest application information. Please note, however, that this is a specification guide only. **The information in this manual is not intended to supersede local building codes.** Refer to local building codes for more information.

General Specification Data

1. The contractor shall cover all roof surfaces with (specify one type of the following product) Certi-Split® shakes/Certi-Sawn® shakes/Certigrade® shingles bearing the Cedar Shake & Shingle Bureau®'s official grade marked label.
2. Shakes/shingles for roofs shall be (specify grade and length).
3. Shakes/shingles for outer courses shall be (specify grade and length).
4. Shakes/shingles for undercourses shall be (specify grade and length).
5. Roof shakes/shingles shall be laid with a weather exposure of (specify in inches).

Roof Application-Sheathing Boards

6. Certi-Split® shakes/Certi-Sawn® shakes shall be applied over solid sheathing. A solid deck is recommended in seismic activity, hurricane and tornado regions and in areas where wind-driven snow is encountered and under pressure-impregnated treated shakes and shingles. Please note that the only solid sheet sheathing tested with Certi-label® shakes & shingles is plywood. Check with your local building code official for plywood thickness/dimensions.

Certi-Split® shakes/Certi-Sawn® shakes/Certigrade® shingles may also be applied over spaced sheathing.

7. All open sheathing shall be 1 x 4 or 1 x 6 boards (minimum 1 x 4 for both shakes and shingles).
8. All solid sheathing shall be lumber or structural panels applied according to specifications of the American Plywood Association. Please note: the only solid sheet sheathing tested with shakes and shingles is plywood. Check with your local building official for plywood thickness/dimensions.

Roofing Felt Interlay (for shakes only)

9. Contractor shall apply a 36" wide strip of No. 30 ASTM D226 Type II or No. 30 ASTM D4869 Type IV roofing felt at the eave line. An 18" wide strip of No. 30 ASTM D226 Type II or No. 30 ASTM D4869 Type IV roofing felt shall be applied over the top portion of the Certi-label® shakes and extend onto the sheathing. Bottom edge of felt shall be positioned at a distance above the butt equal to twice the weather exposure.

Note: Felt interlay between courses is not necessary when straight-split, or taper-split shakes are applied in snow-free areas at weather exposures of less than one-third the total shake length (3-ply roof). Contact the Cedar Shake & Shingle Bureau® for more information or visit www.cedarbureau.org

Roofing General Application Data

10. Certi-label® shakes/shingles shall be at least doubled at all eaves.
11. Butts of the Certi-label® shakes/shingles in the first course on roofs shall project 1 1/2" from the edge of roof eaves to insure proper spill into gutters and approximately 1" at gable and rake edge.
12. Certigrade® shingles shall be spaced apart not less than 1/4", not more than 3/8".

13. Certi-Split® or Certi-Sawn® shakes shall be spaced apart not less than 3/8", not more than 5/8".
14. Premium and Number 1 Grade Certi-label® shakes/shingles shall be applied with the weather exposures consistent with the following tables:

Maximum weather exposure		
Shingle length	3:12 to 4:12 roof slope	4:12 and steeper
16"	3 3/4"	5"
18"	4 1/4"	5 1/2"
24"	5 3/4"	7 1/2"
Shake length and exposure		
18"		7 1/2"
24"		10"
Note exception for resawn shakes: 24" x 3/8" shake = 7 1/2"		

15. Chimney flashing shall extend up the chimney to a height not less than 3", up the roof slope to a point equal in height to the flashing on the chimney but never less than 1 1/2 times the Certi-label® shake/shingle exposure. (All metal flashings should be painted.)
Manufactured step-flashing:
5" x 7" shingle = 2 1/2" wall, 2 1/2" roof
8" x 12" shakes = 4" wall, 4" roof
Step flashing shall be a minimum height of 3", however greater heights are often required. Check with local building code official for step flashing height.
16. Apron counter flashing shall extend to within 1" of the surface of the finished roof.

17. Where saddles or crickets are formed in back of chimneys, curves or similar vertical surfaces, they shall be carried not less than 10" under the Certi-label® shakes/shingles.
18. Step flashing shall be used where vertical surfaces occur in connection with slopes. They shall be formed of separate pieces. Flashing shall extend horizontally not less than 3" and up the vertical wall so that they shall be lapped by the counter flashing not less than 4". It shall be installed in step fashion and each piece shall lap not less than 3" (one flashing installed on each course concealed under the covering course). If other than masonry is used the flashing shall extend up the wall not less than 3" behind the sheathing paper.
19. Dormer flashings shall run 3" up under the sheathing paper and not less than 3" horizontally.
20. Window caps and all other projections at points where rain water accumulates must be provided with flashings, such flashings must extend a distance of at least 3" up the wall behind the sheathing paper.
21. Soil pipes: Metal shall extend no less than 6" in all directions and shall be installed to lap and shed water to the Certi-label® shakes or shingles below.

Hips and Ridges

22. All Certi-label® shake/shingle hips and ridges shall be of alternate overlap type applied at the same exposure as field of roof and with nails long enough to penetrate into sheathing at least 3/4", position fasteners approximately 2" above exposure line. Install a strip of felt, eave protection material or metal over hip or ridge under the ridge or hip cap. If longer or shorter ridge cap is used, adjust exposure accordingly.

Valleys

23. Certi-label® shakes/shingles extending into the valley shall be sawed to the proper miter.
24. Do not lay shakes or shingles with grain parallel with the centerline of valleys.
25. All valleys shall be installed with Certi-label® shakes/shingles lapping the valley flashing not less than 7" on each side.
26. On Certi-label® shingle roofs of less than 6:12 slope, flashing should extend at least 11" on each side.
27. For Certi-label® shakes, metal valley sheets shall be center-crimped; of 20" minimum width; underlaid with a strip of No. 30 ASTM D226 Type II or No. 30 ASTM D4869 Type IV roofing felt over the sheathing, and coated with a metal paint.
28. Valley metals that have proved reliable in a particular geographic region should be selected. Copper flashing: check with local building code official on the durability of copper valleys in your area.

Fasteners

29. **For projects within 15 miles of salt water** – Certi-label® roof shakes and shingles shall be secured with two (2) stainless steel Type 316 nails.
For locations outside the 15 mile range of salt water – Certi-label® roof shakes and shingles shall be secured with two (2) fasteners: stainless steel Type 304, Type 316, or hot-dipped galvanized with a coating weight of ASTM A153 Class D (1.0 oz/ft²).

For Pressure-Impregnated Treated Products

Fasteners used with fire-retardant-treated (Certi-Guard®) or preservative-treated (Certi-Last®) shakes or shingles *must be* stainless steel Type 316. For specifics on installation, accessory building materials (flashing, etc.), finishes and maintenance please contact the treatment company directly.

Fasteners shall be long enough to penetrate into the solid wood sheathing at least 3/4" or all the way through.

30. Nails shall be driven flush but not so that the nail head crushes the wood. They shall be placed approximately 3/4" to 1" from the side edges of the shakes/shingles and approximately 1 1/2" above the butt line of the following course.
31. Each Certi-label® roof shake/shingle shall be secured with two full-driven, corrosion-resistant fasteners. (Specify size and type.)
32. Ensure that fasteners used are accepted by your local building code official.

Shingles:

33. Use 3d "box" nails for new roofs with 16" and 18" shingles.
34. Use 4d "box" nails for new roofs with 24" shingles.
35. Use 5d "box" nails for over-roofing with 16" and 18" shingles, and for hips and ridges.

Shakes:

36. Use 5d "box" nails for new roofs with 18" straight-split shakes.
37. Use 6d "box 2" nails for new roofs with 18" and 24" handsplit-and-resawn shakes.
38. Use 5d "box" nails for new roofs with 24" tapersplit.
39. Use 6d "box 2" nails for new roofs with 18" and 24" tapersawn.
40. 6d nails are usually adequate for Certi-label® shakes, but longer nails shall be used as Certi-label® shake or shingle thickness or weather exposure dictates.

©2020 004

CERTI-SPLIT®

NUMBER 1 GRADE

Handsplit Red Cedar Shakes
CEDAR SHAKE & SHINGLE BUREAU
 THE RECOGNIZED AUTHORITY SINCE 1915
 SUMAS WASHINGTON (604) 820 7700

**LIFETIME LIMITED WARRANTY AVAILABLE FROM CSSB MEMBER MANUFACTURER BELOW
 WHEN APPLIED BY A CSSB MEMBER CONTRACTOR/INSTALLER**

<p>Quality Control Agency Logo</p> <p>Mill Quality Certification Number</p>	 Cedar Shake & Shingle Bureau Label ID Number	<p>Building Code Standards</p> <p>Product Testing Numbers</p>
---	--	---

Litho in Canada www.cedarbureau.org Country of Manufacture

Mill Name
 Mill Location
 Mill Phone Number

 7 20454 00004 2

ENVIROSMART®

PACKING

HEAVY RESAWS
24" x 3/4"
 (610.0 mm X 19.0 mm)

COVERAGE CHART	
100 sq. ft. (9.30 m ²)	
BUNDLES	EXPOSURE
5	10" (254 mm)

- | | |
|--|---|
| <ol style="list-style-type: none"> 1. The "Certi" Brand Name - Your Quality Assurance 2. Product Grade 3. Product Type 4. Independent, 3rd Party, Quality Control Agency 5. This Number Shows Compliance with Total Quality Manufacturing System 6. Mill Name, Location and Phone Number 7. Industry Product Description | <ol style="list-style-type: none"> 8. Product Dimensions 9. Cedar Bureau Label Number 10. Building Code Compliance Numbers 11. Product Performance Tests Passed 12. Label Identification Number 13. UPC Code 14. Coverage Chart and Recommended Exposure 15. Application Instructions on Reverse Side |
|--|---|



1920s: Chief Inspector Fred Monte inspecting product

On June 9, 1915, at a meeting of the Trustees of the West Coast Lumber Manufacturers Association, it was agreed to establish a branch of the association to serve those members who manufactured shingles. Our influence grew, and as we survived both the Great Depression and World War II, manufacturers continued their quality commitment. In 1963, the organization merged with the Handsplit Shake Bureau to become the Red Cedar Shingle & Handsplit Shake Bureau.

Manufacturers' product lines continued to broaden and, in 1988, the members changed the organization's name to the Cedar Shake & Shingle Bureau® ("CSSB"). In the late 1980s, mill quality control inspections were subcontracted to independent, third party quality control agencies.

Each year the CSSB's staff answer thousands of technical questions and product selection queries. Our proud history, quality reputation and dedicated members provide excellent Certi-label® cedar shake and shingle roofing and siding products.



Contact us for more information:

TEL: 604-820-7700

FAX: 604-820-0266

www.cedarbureau.org

info@cedarbureau.com

US Address

PO Box 1178

Sumas, WA

98295-1178

Canadian Address

300 – 34334 Forrest Terrace

Abbotsford, BC

V2S 1G7

This manual shows Cedar Shake & Shingle Bureau® recommended procedures as of the manual's print date. It is advisable to contact the Cedar Shake & Shingle Bureau® to ensure that you are using the latest available information.

Cedar Shake & Shingle Bureau®, the CSSB logo® ("C" with shingles/shakes), Blue Label®, Certigrade®, Certigroove®, Certi-Cut®, Certi-Guard®, Certi-label®, Certi-Last®, Certi-Ridge®, Certi-Sawn®, Certi-Split®, Certi-Wood®, EnviroSMART® and The Crowning Touch of Quality & Design® are all registered trademarks of the Cedar Shake & Shingle Bureau®.



**Forestry Innovation
Investment®**

March 2020 Edition
Printed in Canada